

# DPA-570<sup>®</sup>M

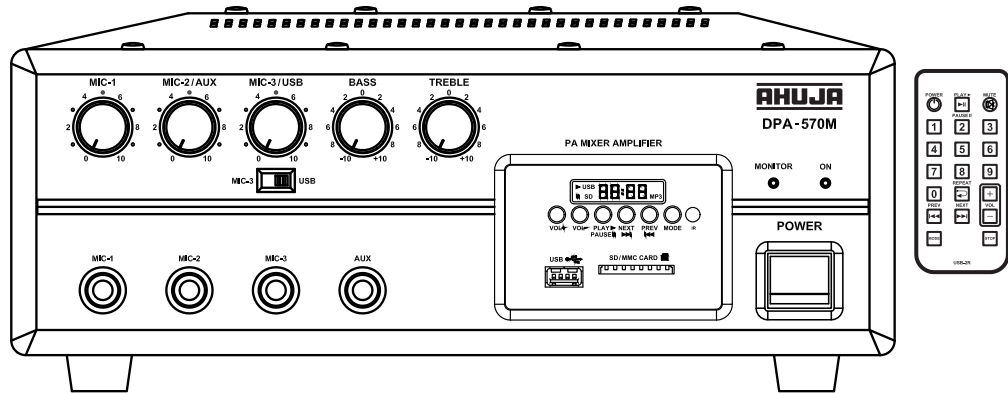

### FEATURES

- PA Mixer Amplifier with built-in MP3 Player and Remote Control.
- Bluetooth Facility.
- Provision for automatic changeover from AC to Battery Operation ensuring continuity of program.
- 100V line for long distance speaker connections.
- Separate active BASS and TREBLE controls for shaping tonal quality of music & speech as desired.
- LINE OUT for connecting additional booster amplifier.
- Three low impedance Microphone inputs and one Aux. Input. The Aux input is for connecting Mixer, CD Player, etc.

### SPECIFICATIONS

|                    |  |
|--------------------|--|
| Power Output       | : 75W RMS (max)<br>: 50W RMS at 10% THD (Rated)<br>: 45W RMS at 5% THD |
| Input Channels     | : 3 × Mic 0.6mV (Lo-Z) / 4.7kΩ<br>: 1 × Aux 100mV / 330kΩ              |
| Frequency Response | : 50Hz -15,000Hz ±3dB  |
| S/N Ratio          | : >55dB  |
| Tone Control:      | : Bass: ±10dB at 100 Hz<br>: Treble: ±10dB at 10 kHz                   |
| Speaker Output     | : 4Ω, 8Ω, 16Ω & 100V   |
| Line Output        | : 400mV / 3.5 kΩ   |

### DIGITAL PLAYER

: MP3 Player with USB, SD/MMC Card Reader & Bluetooth

### GENERAL

|                   |   |
|-------------------|---|
| Power Supply      | : AC: 220-240V 50/60Hz*<br>: DC: 12-14 V Car Battery        |
| Power Consumption | : AC: 90VA at rated output<br>: DC: 3.1 A / 12V             |
| Protections       | : AC: Fuse 1Amp. 250V (T 1A L)<br>: DC: Fuse 8Amp. (T 8A L) |
| Indicators        | : Pilot LED Monitor   |
| Dimensions        | : W305 × H120 × D305 mm                                     |
| Weight            | : 7.00 kg approx.   |

\* This unit is connected to 240V tap when leaving the factory.  
Owing to continuous product up-gradation, design & specifications are subject to change without notice.  
Specifications claimed are subject to permissible production tolerances.

- ◆ Please read this manual thoroughly before making connections and turning on the power. Following the instructions in this manual will enable you to obtain optimum performance from your new AHUJA PA Mixer Amplifier.
- ◆ Please retain this manual for future reference.

## • Front & Rear Panel Controls & Features

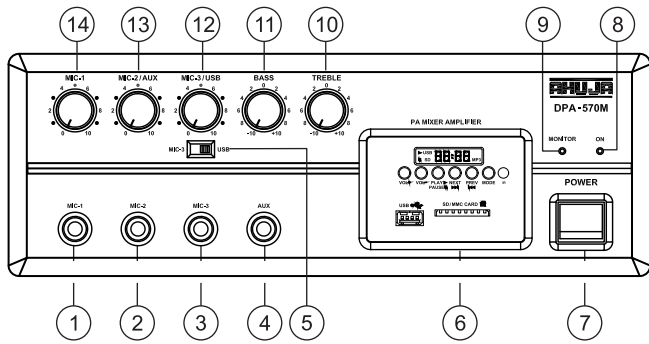

1. **MIC-1 Input Jack Socket:** For Connecting a low impedance microphone.
2. **MIC-2 Input Jack Socket:** For connecting a low impedance microphone.
3. **MIC-3 Input Jack Socket:** For connecting a low impedance microphone.
4. **AUX Input Jack Socket:** For connecting an auxiliary source like a CD player, Tuner, Echo or Audio Mixer etc.
5. **MIC-3 /USB Selector Switch**
6. **MP3 Playback Facility:** For details see prints A to F.
7. **POWER switch:** Push the top part of the knob to switch the amplifier ON. Push the bottom part of the knob to switch the amplifier OFF.
8. **POWER LED:** This LED glows to indicate that the set is ON.
9. **MONITOR LED:** For output indication.

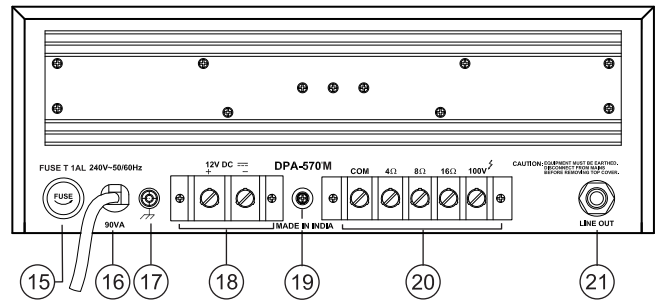

10. **TREBLE Control:** For controlling the high frequency signals.
11. **BASS Control:** For controlling the low frequency signals.
12. **MIC-3 /USB Volume Control**
13. **MIC-2 /AUX Volume Control**
14. **MIC-1 Volume Control**
15. **AC Mains Fuse Rating 1Amp. 250V (T 1A L)**
16. **AC Mains Cable with plug**
17. **EARTH Terminal**
18. **BATTERY Terminal Strip:** For connecting a 12V car battery.
19. **ABS Legs:** For supporting the unit on its back while handling.
20. **SPEAKER Terminal Strip:** For connecting Speakers or Driver Units.
21. **LINE Output Jack Socket:** For connecting additional higher wattage amplifier for obtaining more power output.

## • MP3 Playback Facility: Controls & Features

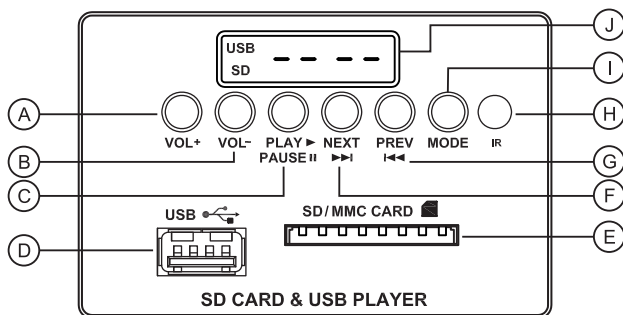

- A. **VOL+ :** To increase volume level of MP3 player.
- B. **VOL- :** To decrease volume level of MP3 player.
- C. **▶||PLAY/PAUSE:** Press PLAY/PAUSE once to Pause if music is already playing. Press PLAY/PAUSE again to resume playing.
- D. **USB Connector:** Insert the USB drive here. While inserting USB drive into the USB connector, hold the USB drive in such a way that hollow part of the USB drive is downwards as shown in Figure. Any forceful insertion in wrong direction will damage the connector.

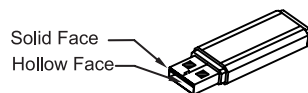

- E. **SD/MMC Card Connector:** Insert the SD/MMC Card into the slot to play. When taking out the card, push the card to take out.

While inserting SD/MMC card into the slot, ensure that the card is inserted in such a way that all pins are facing upward and cut is towards left as shown in figure.

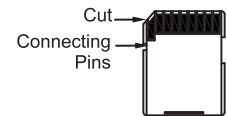

- F. **▶▶ Next:** Press NEXT to select next forward music track. Pressing NEXT repeatedly will move the system to successively next forward tracks. Then press PLAY/PAUSE for playing the track so selected.
- G. **◀◀ Prev:** Press PREV to Select the previous track. Pressing PREV repeatedly will move the system to successively previous tracks.
- H. **IR Sensor:** Picks up signal from the Remote control. Point the Remote control toward this sensor for the best results.
- I. **Mode:** To select USB, SD or Bluetooth. Default condition of the set is USB or SD whichever is inserted.
- J. **LED Display:** Instantly displays 3 digits of the track selected play to i.e 001 to 999. During play, display the time duration of the track played.

## • Remote Control

### Remote Control

- K. Power:** Press once to switch off MP3 player, press again to switch ON.
- L.** Number key 0 to 9. To choose the track number to be played.
- M. ⏮:** To select the previous track.
- N. MODE :** To select SD, USB or Bluetooth Option.
- O. ⏭:** Press to select the next track.
- P.** ↻ Press once to repeat the song being played. Press twice to repeat all the songs.
- Q. STOP:** Press to stop the track being played.

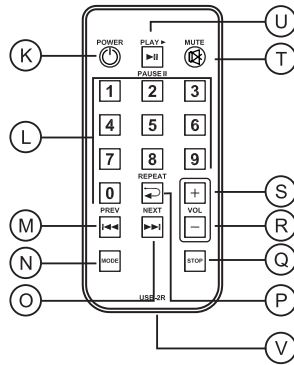

- R. Vol- :** Press to decrease the volume of MP3 Player.
- S. Vol+ :** Press to increase the volume of MP3 Player.
- T. MUTE:** Press once to mute the sound, press again to resume the sound.
- U. ▶|| PLAY/PAUSE:** Press Play/Pause once to Pause when music is already playing. Press Play/Pause again to resume playing.
- V. Battery Replacement:** Pull out the battery tray and replace the battery with positive electrode facing upwards as shown in fig. below. Push the battery compartment back to the close position. Use CR2025 or equivalent lithium coin cell.

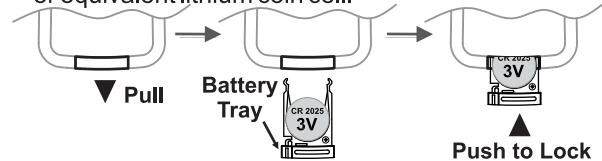

## • Pairing of Bluetooth Device

SWITCH ON the amplifier in use. The Default condition of the MP3 digital Player is USB/SD mode. The display shows — — — . To play the MP3 programme from mobile phone or laptop via bluetooth, the PAIRING of the Bluetooth devices of mobile phone & amplifier is necessary. To use Bluetooth, Press Mode switch to select Bluetooth.

### Pairing is done as follows:

SELECT the Bluetooth option in Mobile Phone or laptop & follow the instructions appearing on mobile/laptop screen.

### Normally the following general instructions are followed:

Press ACTIVATE /ON/DISCOVERABLE/SEARCH, etc, as applicable in the mobile phone or laptop used.

The mobile phone or laptop starts searching for the new Bluetooth device. The moment Bluetooth appears on the mobile phone or laptop, select the new device i.e. Bluetooth and press OK or allow it to appear on mobile. System is ready to use.

In some mobiles, it asks for a code to allow access. Press 0000 and follow the steps, like pressing "OK", "Allow once", "Allow always" etc. and make the device ready for use.

Select the MP3 programme from mobile phone or laptop and press PLAY. The same song starts playing on the Ahuja amplifier. We can SELECT Volume, Fast Forward, Rewind, Play/Pause function either from keys or through Remote Control.

**Note:** It is not necessary that all functions of remote control will be activated through Bluetooth and compatibility varies from mobile to mobile.

## • Speaker Connections

### Low Impedance

Speaker impedance taps of 4, 8 and 16 ohms have been provided for direct connection of speakers to the amplifier when the distance between the amplifier and speakers is less than 50 meters. Use 23/36 or thicker cable for connections. Be sure that total impedance of speakers is equal to or above the impedance specified on the terminal strip.

### 100V Line

When it is desired to connect speakers or driver units at a distance over 50 meters, it is recommended that the 100V line output be used together with line matching transformer for each speaker. This prevents excessive power loss in the speaker cables.

### Phasing of loudspeakers/units

When two or more speakers / units are installed in the same area and are facing in the same direction, it is essential that their cones / diaphragms move in unison. Otherwise, the sound output of one speaker will cancel the sound output of the other. To avoid any mistake, the terminals of box speakers are marked '+' & '-'. Always connect the COM of the amplifier to the '-' of speakers & 4Ω / 8Ω / 16Ω terminal of the amplifier to the '+' of the speakers.

The terminals of speakers / units with LMT are marked COM and power tapping. COM of these speakers / units should be connected to the COM of the terminal strip of the amplifier and the power tap to 100V line.

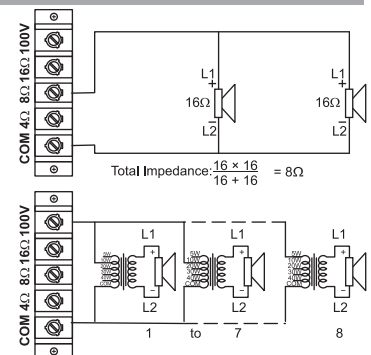

**IMPORTANT: Speaker impedance mismatch may cause insufficient output or over heating of the components which may result in failure of components.**

## • Operating Procedure

1. Set all volume controls to '0' position and keep the power switch at OFF position. Connect the speakers and required inputs.  
Plug in the AC power supply cord to the nearest AC mains socket and put the power switch to POWER position. The pilot LED should glow.
2. Select the desired MIC input to use and increase the individual control to desired level.
3. Select MIC/USB Switch to desired input e.g USB or MIC-3.
4. For USB:
  - Select the MIC/USB Switch to USB
  - Insert pen drive to USB port, it starts playing automatically from the 1st track or from the last track played if the same pen drive is used earlier.
- Use Remote Control to select the desired track. Use Volume button on the remote control to adjust desired USB playback level.
- Setting of last volume level remains in memory even when power failure occurs.
5. Bass and Treble setting can be done for desired tonal quality.
6. Use remote control to switch OFF the USB MP3 Player while not in use.  
If power to the amplifier is switched OFF and ON again, the USB function will automatically switch ON again.
7. To use bluetooth, select the option using MODE key & pair the devices as per instruction above. After pairing is complete, select the desired track from mobile or laptop to play.

## • Safety Instructions

**Read the Instructions:** Please read all the instructions in this section carefully before installation or use of the product. All the safety instructions must be followed & the Manual for future reference.

**Retain the Instructions:** Please retain this Instruction Manual for future reference.



This symbol, wherever it appears, alerts you to the presence of uninsulated hazardous voltage that may be sufficient to constitute a risk of electric shock. External wiring to any terminal marked with this symbol must be done by a trained and instructed person only.



This symbol, wherever it appears adjacent to a component, alerts you that the concerned component can only be replaced by another of the exact same specifications.

### WARNING

- To reduce the risk of electric shock, do not remove the top cover. No user serviceable parts inside. Refer all servicing to qualified personnel only.
- Before replacing any fuse, make sure the set is switched off and disconnected from the AC mains or any other power source. Replace a fuse only with another of exactly same specification.

### CAUTIONS

**Water & Moisture:** To reduce the risk of fire or electrical shock, do not expose this set to rain or moisture. Do not use this set near water or in a wet location. Do not keep any

object filled with liquid, such as a vase, on top of this set. Do not insert or remove the AC mains plug with wet hands.

**Power Source:** The voltage & frequency of the AC mains supply, and the voltage of the external battery, (if applicable) to which this set can be connected, is marked on the rear panel of the set. Do not connect this set to any power source other than those specified on the rear panel.

**Power Cord Protection:** Do not cut, kink, damage or modify the AC power cord supplied with this set. Keep the AC power cord away from heaters and harmful chemicals. Do not keep any heavy object on the power cord.

**Ventilation:** This set should be situated so that its location or position does not interfere with its proper ventilation. Do not cover the ventilation holes / slots. Do not insert or drop anything into the ventilation holes / slots.

**Stability:** This set must be kept in a stable and flat horizontal position, and never in a tilted position. Do not place this set on an unstable stand, tripod, bracket or mount. Do not use attachments which are not supplied or explicitly recommended by the manufacturer.

**Cover Strip:** The cover strip of the 100V / 70V audio output terminal strip must be replaced after making connections.

**Earthing:** This set must be earthed properly before use. A wire from the Earth terminal on the rear panel must be connected to electrical earth.

**Cleaning:** Disconnect this equipment from the AC mains and external battery before cleaning. Clean with a damp cloth, but do not allow any liquid to enter the set. Do not clean with liquids or aerosols.

**Exposure to Heat:** Do not touch the heatsinks while the set is working.

Design and Specifications are subject to change without notice owing to continuous product up-gradation. Technical specifications are subject to production tolerances.

We cannot be held responsible for printing errors, should they occur. AHUJA is a registered trademark of Ahuja Radios in India and other countries.

© Copyright Ahuja Radios, 2019. All rights reserved. Any unauthorized reproduction or use of logos, images or design elements is strictly prohibited by law.

No part of this compilation may be reproduced in any manner or translated without written permission.

**TRUSOUND PVT. LTD.** • C-89, Sector IV, Noida, Gautam Budh Nagar-201 301 (UP)

Regd. Office : 125E, Okhla Industrial Estate, New Delhi-110 020

Tel.: +91-120-4665665 Fax : +91-120-4665621

E-mail: trusoundsupport@airtelmail.in

E. & O. E.