

UBA-800

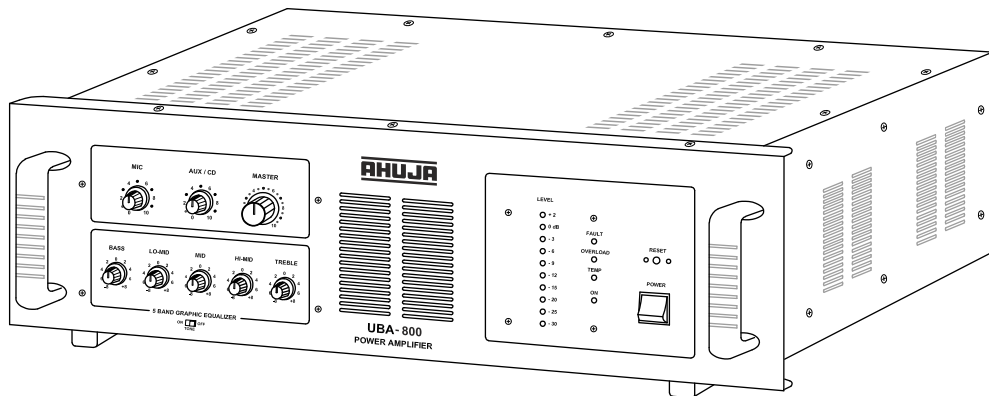

- ◆ Thank you for purchasing the AHUJA PA Amplifier.
- ◆ Please read this manual thoroughly before making connections and turning on the power. Following the instructions in this manual will enable you to obtain optimum performance from your new AHUJA PA Amplifier.
- ◆ Please retain this manual for future reference.

• Safety Instructions

Read the Instructions: Please read all the instructions in this section carefully before installation or use of the product. All the safety instructions must be followed.

Retain the Instructions: Please retain this Instruction Manual for future reference.



This symbol, wherever it appears, alerts you to the presence of uninsulated hazardous voltage that may be sufficient to constitute a risk of electric shock. External wiring to any terminal marked with this symbol must be done by a trained and instructed person only.



This symbol, wherever it appears adjacent to a component, alerts you that the concerned component can only be replaced by another of the exact same specifications.

WARNING

- To reduce the risk of electric shock, do not remove the top cover. No user serviceable parts inside. Refer all servicing to qualified personnel only.
- Before replacing any fuse, make sure the set is switched off and disconnected from the AC mains or any other power source. Replace a fuse only with another of exactly same specification.

CAUTIONS

Water & Moisture: To reduce the risk of fire or electrical shock, do not expose this set to rain or moisture. Do not use this set near water or in a wet location. Do not keep any object filled with liquid, such as a vase, on top of this set. Do not insert or remove the AC mains plug with wet hands.

Power Source: The voltage & frequency of the AC mains supply, to which this set can be connected, is marked on the rear panel of the set. Do not connect this set to any power source other than those specified on the rear panel.

Power Cord Protection: Do not cut, kink, damage or modify the AC power cord supplied with this set. Keep the AC power cord away from heaters and harmful chemicals. Do not keep any heavy object on the power cord.

Operation on Generator: When operating this set on a generator, make sure the set is switched off till the generator voltage has stabilized.

Ventilation: This set should be situated so that its location or position does not interfere with its proper ventilation. Do not cover the ventilation holes / slots. Do not insert or drop anything into the ventilation holes / slots.

Stability: This set must be kept in a stable and flat horizontal position, and never in a tilted position. Do not place this set on an unstable stand, tripod, bracket or mount. Do not use attachments which are not supplied or explicitly recommended by the manufacturer.

Cover Strip: The cover strip of the output terminal strip, must be replaced after making connections. Failure to do so may result in exposure to hazardous voltages.

Earthing: This set must be earthed properly before use. A wire from the Earth terminal on the rear panel must be connected to electrical earth.

Cleaning: Disconnect this equipment from the AC mains and external battery before cleaning. Clean with a damp cloth, but do not allow any liquid to enter the set. Do not clean with liquids or aerosols.

Exposure to Heat: Do not touch the heatsinks while the set is working.

• Table of Contents

Contents	Page No.
• Features/General Description of Product	4
• Front Panel Controls & Features	5
• Rear Panel Controls & Features	6
• Interconnections	7
• Speaker Connection Guidelines	9
• Typical Applications	10
• Specifications	16

• Features/General Description of Product

- Designed for use in a wide variety of PA applications and DJ performances.
- UBA-800 is a 800 Watts amplifier which can be connected to various input sources like a Microphone, PA Mixer, CD player, DJ Mixer, Cassette player, Keyboard etc.
- The amplifier comprises of a 5 band graphic equalizer which provides precise and accurate tonal setting of the programme material.
- Tone ON / OFF switch to bypass tone circuitry.
- Line Input and Line Output have been provided to enable interconnections with other power amplifiers.
- Circuit Protector Device has been provided which safeguards the amplifier against overload and short circuit.
- The amplifier is fully protected for variations in AC supply due to Genset / Mains fluctuation upto 300V.
- Indicator LEDs for Power, Signal, Temp, Overload and Fault conditions have been provided.
- Ease of operation, combined with service accessibility has been optimized in the design.

• Front Panel Controls & Features

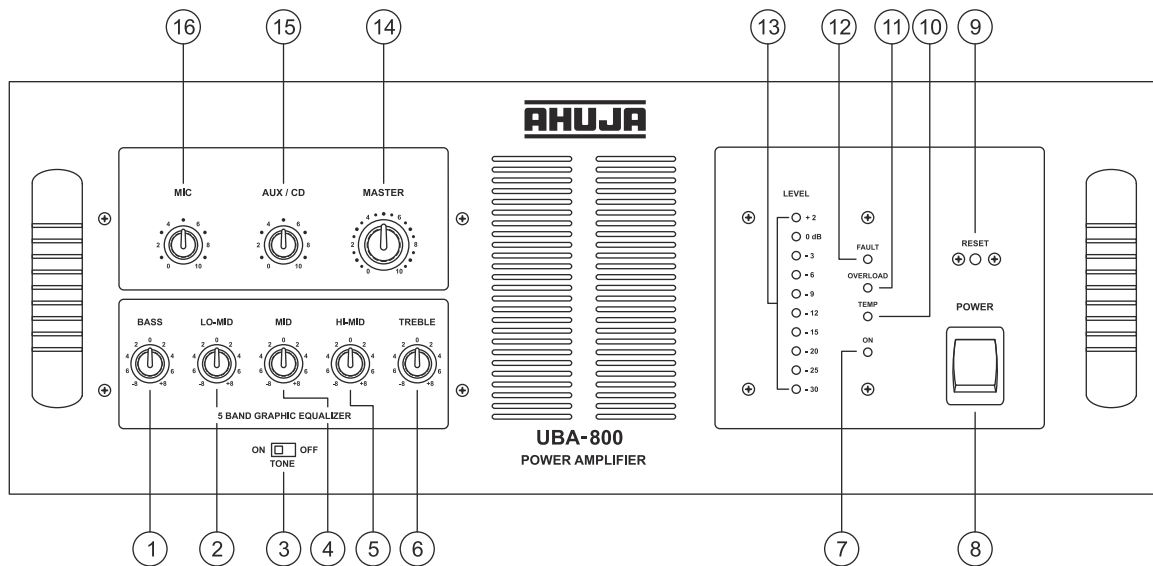

1. **BASS Control**
For attenuating or boosting the low frequency signal level with a centre frequency of 100Hz.
2. **LO-MID Control**
For attenuating or boosting the signal level with a centre frequency of 315Hz.
3. **Tone ON / OFF Switch**
The tone ON / OFF switch bypasses the equalizer circuitry which is useful when Aux Input is feed from a mixer with active equalizer.
4. **MID Control**
For attenuating or boosting the signal level with a centre frequency of 1kHz.
5. **HI-MID Control**
For attenuating or boosting the signal level with a centre frequency of 3kHz.
6. **TREBLE Control**
For attenuating or boosting the high frequency signal level with a centre frequency of 10kHz.
7. **POWER LED**
The glowing of this red LED indicates that the amplifier is switched ON.
8. **POWER Switch**
Push the top part of the knob to switch the amplifier ON. Push the bottom part of the knob to switch the amplifier OFF.
9. **RESET Button**
This button pops out when the circuit protector trips. Rectify the cause and press the RESET button for resetting to normal operation of the amplifier.
10. **TEMPERATURE LED**
The glowing of this yellow LED indicates excessive temperature of the output devices. The protection circuit then mutes the input signals. The amplifier will remain at mute status, till the amplifier cools down to normal temperature.
11. **OVERLOAD LED**
The glowing of this red LED indicates that the circuit protector has tripped. The AC mains supply to the amplifier is cut-off till the fault is rectified and the reset button is pressed.
12. **FAULT LED**
The glowing of this red LED indicates that some fault has occurred in the amplifier. The protection circuit then mutes the input signals. The amplifier will remain at mute status till the fault is rectified.
13. **LED Array**
This indicates the output level of the amplifier. Acceptable output levels are indicated by occasional flickering of the 0dB LED. If this LED glows continuously then it is advisable to reduce the input signal level either from the signal source or the amplifier volume controls.
14. **MASTER Volume Control**
For adjustment of the overall volume level of the amplifier.
15. **AUX / CD Volume Control**
16. **MIC Volume Control**

• Rear Panel Controls & Features

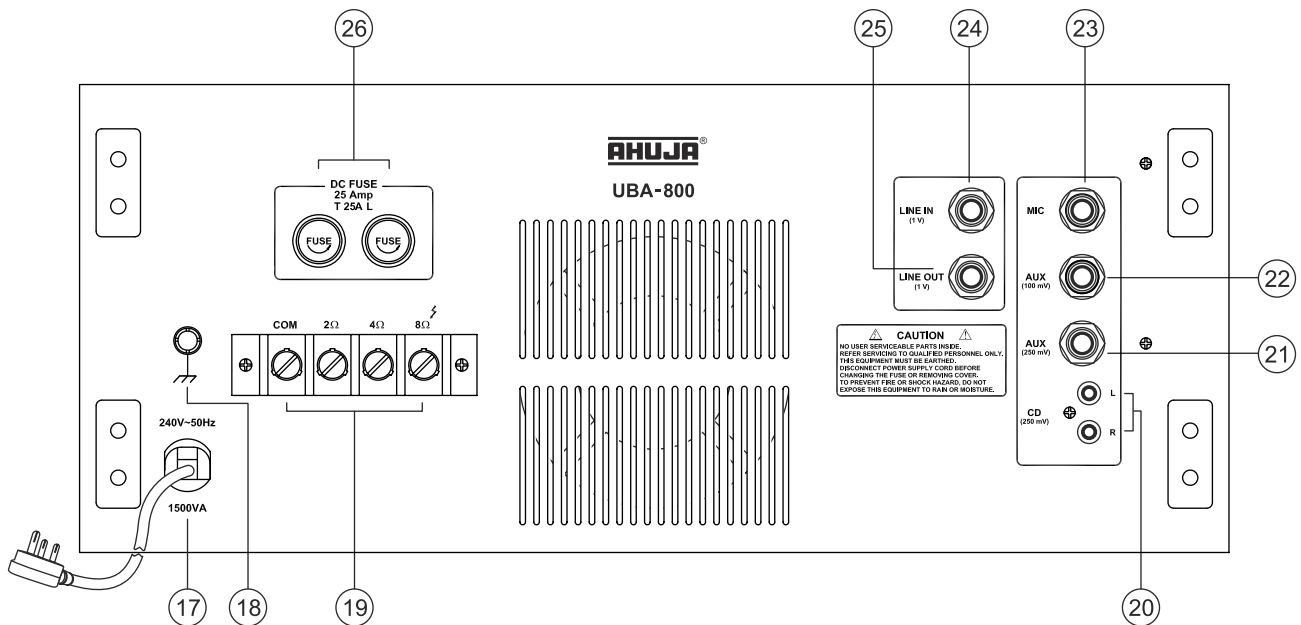

17. 3 Core AC Mains Cable with Plug

18. Earth Terminal

19. SPEAKER Terminal Block (2Ω, 4Ω & 8Ω)

For connecting low impedance speakers.

20. CD Input RCA Sockets

For connecting stereo inputs such as a CD player, DJ Mixer etc.

CD Input should be used only when the Aux Input is not connected.

21. AUX Input Jack Socket (250mV)

For accepting an unbalanced signal from an auxiliary source of higher output mixer, CD Player etc.

22. AUX Input Jack Socket (100mV)

For accepting an unbalanced signal from an

auxiliary source like a Tuner, Cassette Player, Echo Mixer or Audio Mixing Console etc.

Aux Input should be used only when the CD Input is not connected.

23. MIC Input Jack Socket

For accepting unbalanced signal from a low impedance microphone.

24. LINE Input Jack Socket

For connecting an external Mixer to enhance the number of inputs.

25. LINE Output Jack Socket

For connecting to a booster amplifier to obtain combined higher power output.

26. DC Fuses Rating 25 Amp, 250V (T 25A L)

These protect the amplifier from any excessive current flow.

Caution

- The equipment must be earthed properly before operating it to avoid electric shock. A wire from the Earth Terminal must be connected to electrical earth for safe operation.

• Interconnections

- The amplifier can be placed as a tabletop unit. The amplifier uses an efficient forced cooling arrangement, therefore, the amplifier should be situated so that the front and rear ventilation slits are not obstructed.
- The amplifier must be powered through an AC earthed mains outlet.
- All connections must only be carried out or changed with the amplifier switched OFF.
- To avoid loud switching noise, always switch ON the power amplifier after all other units of the audio system have been switched ON. After operation, switch it OFF first and then the other units.
- The connection diagrams that follow, display the typical types of input sources (Mic, Keyboard, Cassette Player, DJ Mixer, CD Player etc.) and box speakers which can be connected to the amplifier. For correct connections and operation check the specifications of the connected equipment.

(Refer to page 8 for illustration)

• Interconnections....

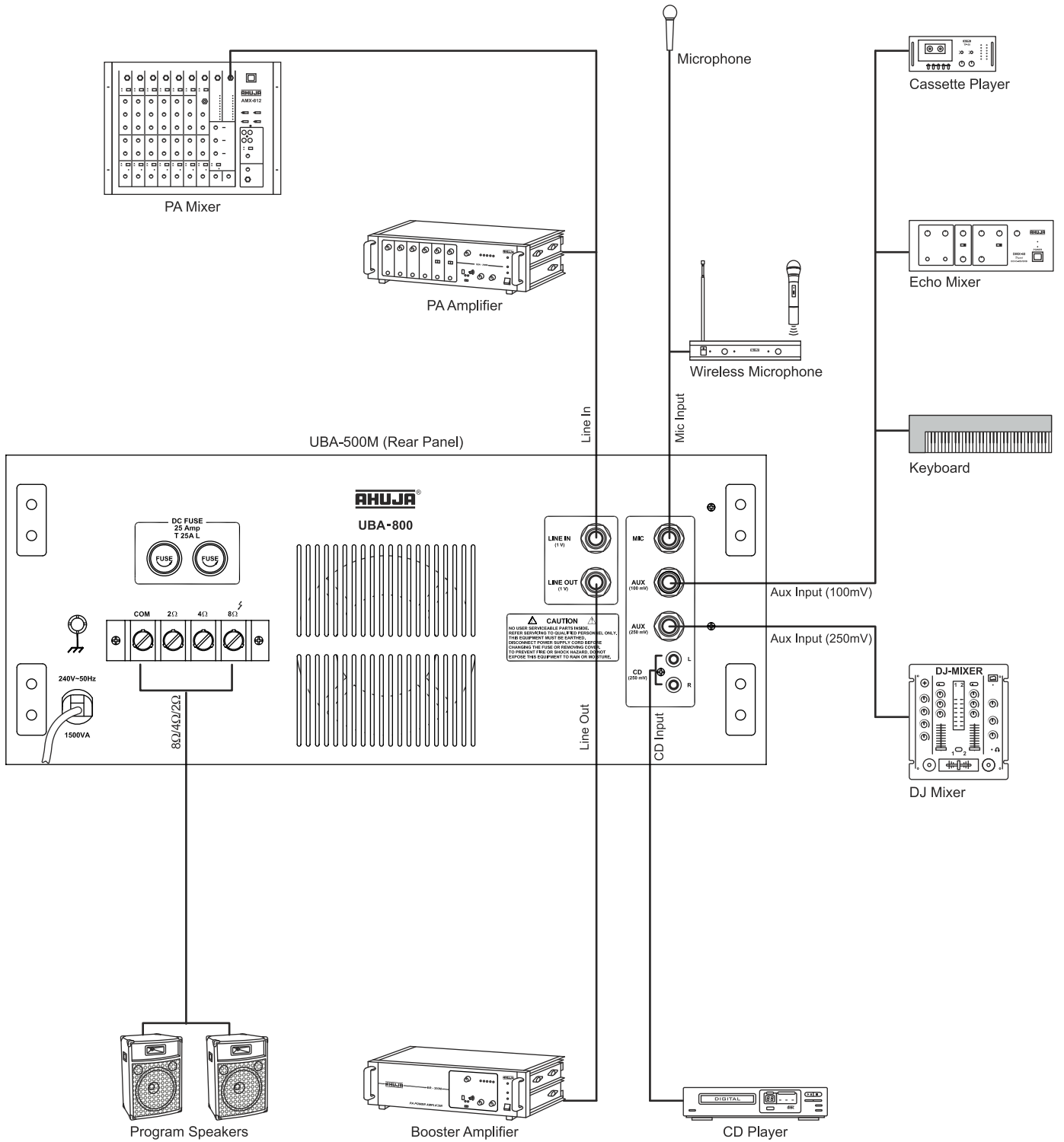

• Speaker Connection Guidelines

UBA-800 is a high-powered amplifier. Therefore it is very important that correct loudspeaker connections are made to avoid damage to the amplifier or speakers.

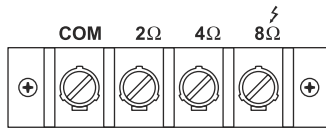

Low Impedance Speaker Connections

- Box type Speakers can be directly connected to Com-2Ω / 4Ω / 8Ω Terminal Strip.

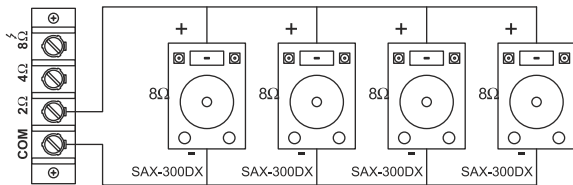

$$\text{Resultant Impedance} = (8\Omega / 4) = 2\Omega$$

Connecting Four SAX-300DX Speakers

The four SAX-300DX Speakers (each speaker has 8Ω impedance) should be wired in parallel as shown in figure. The resulting impedance of the speaker system will be 2Ω. The speaker system should be connected to the 2Ω tap of the amplifier.

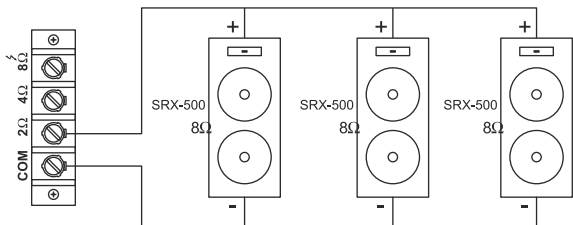

$$\text{Resultant Impedance} = (8\Omega / 3) = 2.66\Omega$$

Connecting Three SRX-500 Speakers

The three SRX-500 speakers (each speaker has 8Ω impedance) should be wired in parallel as shown in figure. The resulting impedance of the speaker system is 2.66Ω. Thus they should be connected to the 2Ω tap of the amplifier.

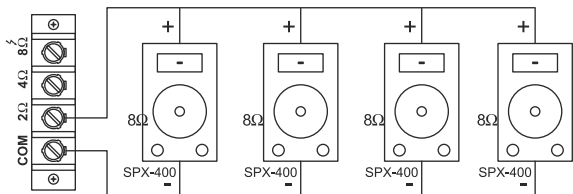

$$\text{Resultant Impedance} = (8\Omega / 4) = 2\Omega$$

Connecting Four SPX-400 Speakers

The four SPX-400 speakers (each speaker has 8Ω impedance) should be wired in parallel as shown in figure. The resulting impedance of the speaker system is 2Ω. Thus they should be connected to the 2Ω tap of the amplifier.



Connecting One SWX-650 Subwoofer

One SWX-650 subwoofer system has an impedance of 8Ω. Thus it should be connected to the 4Ω tap of the amplifier as shown in the figure.

IMPORTANT

- Speakers should be connected only to either COM-2Ω or COM-4Ω or COM-8Ω terminals as illustrated above but never to more than one set of terminals.

• Typical Applications

Connecting Two UBA-800 To Make A 1600W Mono System

1. Connect the Output of the CD Player to the CD Input of the first UBA-800 using a patch cord with RCA plugs at both ends.
2. Connect the Line Out of the first UBA-800 to the Line In of the second UBA-800 using a patch cord with ¼" phone plugs at both ends.
3. Loudspeaker connections to both the amplifiers should be done independently. Each amplifier is connected to a speaker stack which comprises of four SAX-300DXs.
4. The four speakers in each stack will be wired together in parallel (resulting impedance is 2Ω) and connected to the COM and 2Ω tap of their respective UBA-800s.
5. Finally, when operating the system, any adjustment in the overall tonal quality of the sound can be made through the 5 band graphic equalizer of the first UBA-800 only.
6. This MONO system is capable of delivering output power of 1600W at 10%THD which is suitable for various indoor as well as outdoor applications.

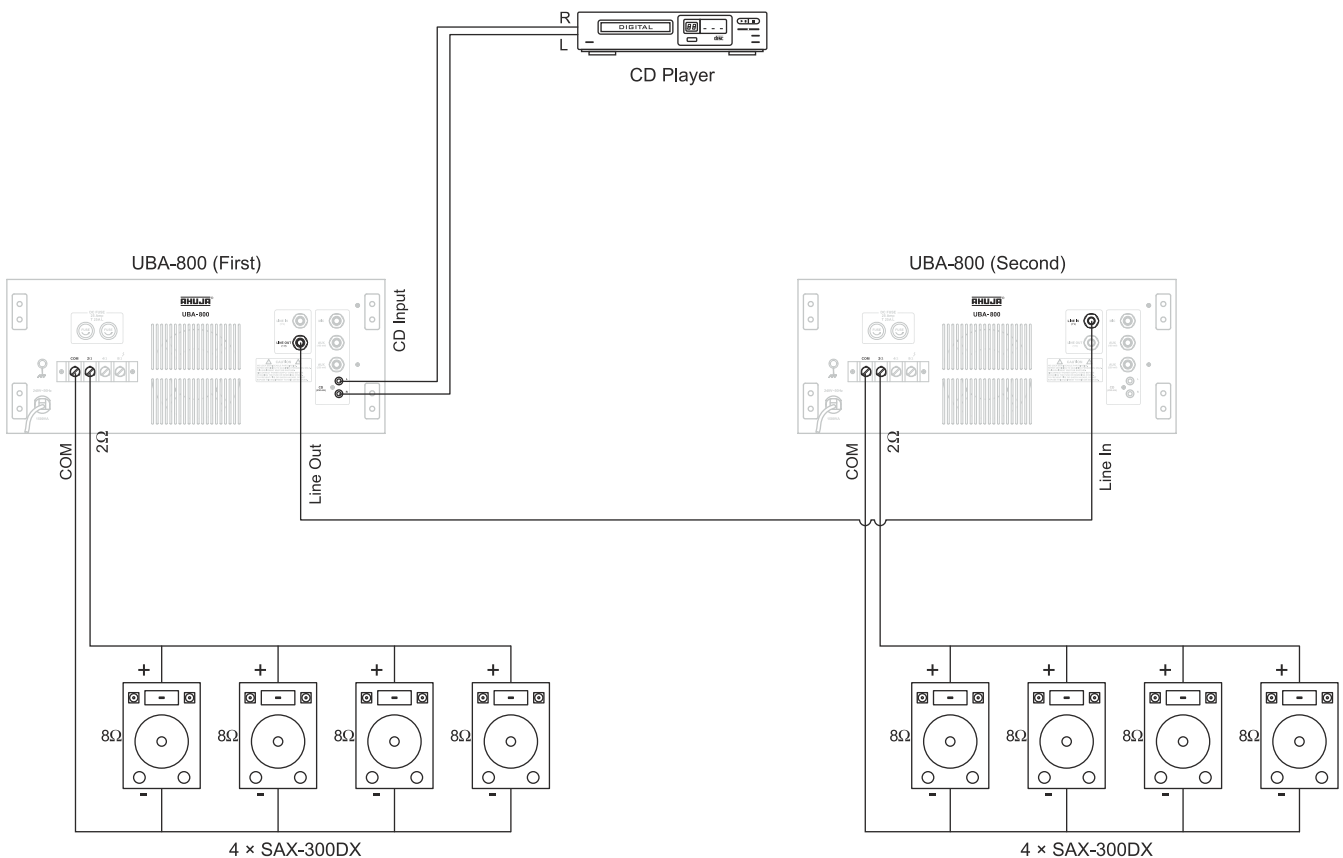

Connecting Two UBA-800 For Making A 1600W Stereo System For DJ Applications

1. Connect the Left output of a CD Player to either Aux Input or Left CD Input of the UBA-800 (Left) and Right output of the CD Player to the Aux Input or Right CD Input of the UBA-800 (Right), using a suitable patch cord.
2. The left and right speaker stacks comprise of three SRX-500s on each side. The three speakers in each stack will be wired together in parallel (resulting impedance is 2.66Ω). Each stack would be independently connected to the COM and 2Ω tap of their respective UBA-800s.
3. Finally, when operating the system, any adjustment in the tonal quality of the sound can be made separately through the 5 band graphic equalizer of each UBA-800.
4. This STEREO system is capable of delivering output power of 800W at 10% THD per channel which is ideal for large size gatherings.

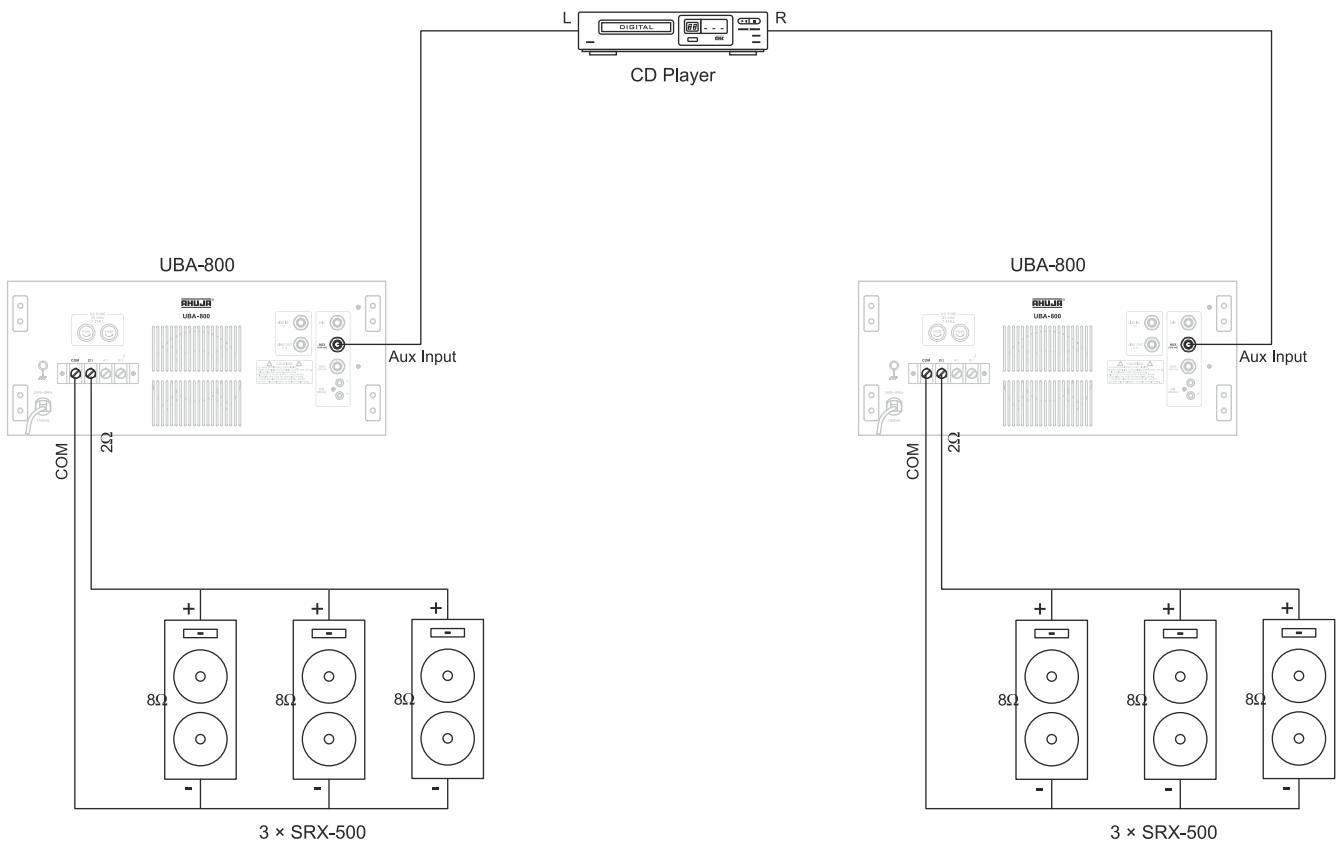

• Typical Applications....

Connecting Five UBA-800 To Make A 4000W Mono System For Large Outdoor Programme

1. Connect a Microphone and other Program Sources like a Cassette Player or a CD Player to the first UBA-800 (Master).
2. Connect the Line Out of the first UBA-800 (Master) to the Line In of the second UBA-800 (Booster A) using a patch cord with ¼" phone plugs at both ends.
3. The Line Out of the second UBA-800 (Booster A) should be connected to the Line In of the third UBA-800 (Booster B) using a patch cord with ¼" phone plugs at both ends.
4. The fourth and fifth UBA-800 (Booster C and Booster D) should be connected in the same way.
5. Speaker connections to each of the five amplifiers should be done independently. Each of the amplifier can be connected to a speaker stack that consists of four SAX-300DX wired in parallel (resulting impedance is 2Ω).
6. The impedance of each speaker stack should be matched to the output impedance of their respective amplifiers and thus should be connected to the corresponding tap of the amplifier.
7. Finally, when operating the system, any adjustment in the overall tonal quality of the sound can be made through the 5 band graphic equalizer of the first UBA-800 (Master) only.
8. This MONO system is capable of delivering output power of 4000W which is ideal for large outdoor programmes.

(Refer to page 13 for illustration)

• Typical Applications...

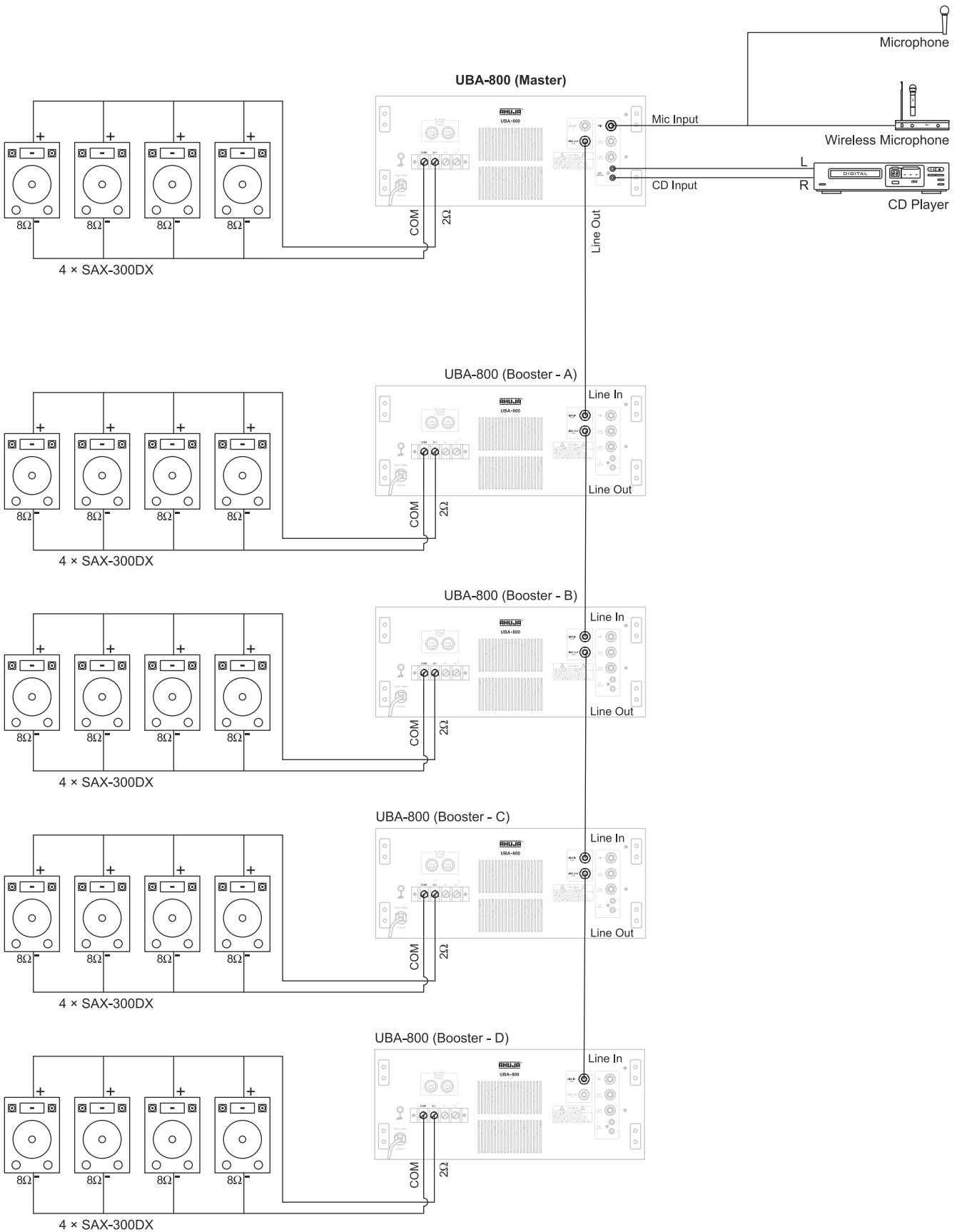

• Typical Applications....

Connecting Eight UBA-800 For A Live 3200W +3200W at 10% THD Stereo DJ Programme

1. Connect the output of the Twin CD Player to the Stereo Line Input of a DJ Mixer.
2. Connect the Left and Right Outputs of the DJ Mixer to the respective inputs of an Active Crossover using a suitable patch cord.
3. Connect the Left Low frequency output of the active crossover to the Line In jack of first left channel UBA-800 (Booster - AL) using a patch cord with ¼" phone plugs at both ends.
4. Similarly, the Right Low frequency output of the active crossover should be connected to the right channel UBA-800 (Booster - AR) as shown in the diagram.
5. The Left and Right Low frequency speaker stacks comprise of two SWX-650s on each side. The Parallel combination will be connected to the COM and 4Ω tap of a UBA-800.
6. Now connect the Left High frequency output of the active crossover to the Line In jack of third left channel UBA-800 (Booster - BL, CL) using a Y patch cord with ¼" phone plugs at ends.
7. The Line Out of Booster - CL should be connected to the Line In jack of the fourth UBA-800 (Booster - DL).
8. Similarly, the Right Low frequency output of the active crossover should be connected to the three right channel UBA-800s (Booster - BR, CR, DR) as shown in the diagram.
9. The Left and Right High frequency speaker stacks comprise of twelve VS-300s on each side. Each stack will have two columns of four VS-300s. Each column would be independently connected to the COM and 2Ω tap of a UBA-800.
10. Finally, when operating the system, any adjustment in the overall tonal quality of the sound can be made from the DJ Mixer.
11. This STEREO system is capable of delivering output power of 3200W at 10% THD per channel and will render high quality rich powerful sound both in large indoors as well as outdoor applications.

(Refer to page 15 for illustration)

• Typical Applications....

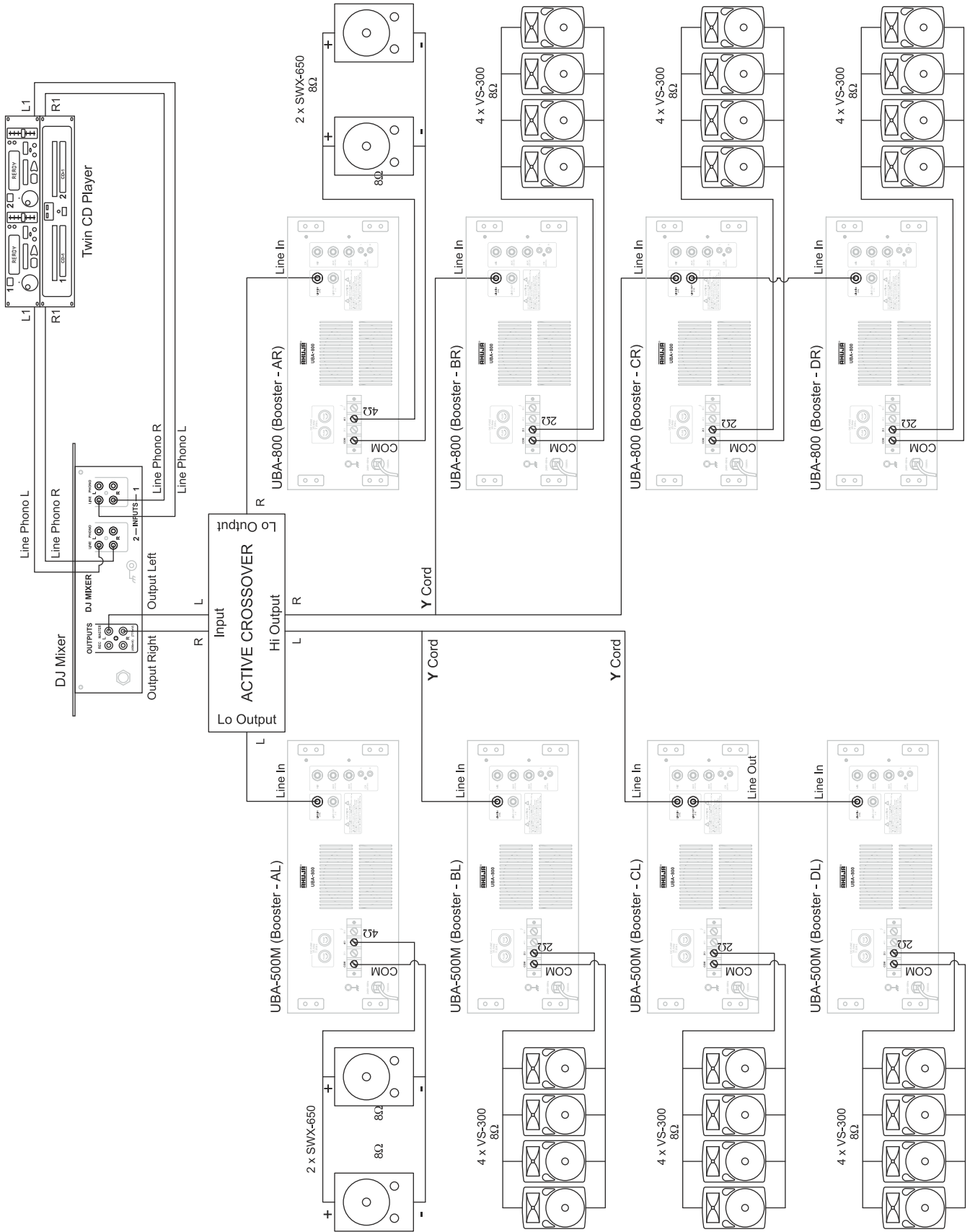

• Specifications

MODEL	UBA-800
Power Output	1050W RMS Max. 800W RMS at 10%THD 750W RMS at 5% THD 700W RMS at 2% THD
Output Regulation	≤ 2dB no load to full load at 1kHz
Input Channels	1 × Mic 1mV / 4.7kΩ (Mic source impedance 50Ω to 1kΩ) 1 × Aux 100mV / 470kΩ 1 × Aux 250mV/20kΩ 1 × CD 250mV / 20kΩ Line Input 1V / 10kΩ
Frequency Response	50Hz–18,000Hz ±3dB
Signal to Noise Ratio	60dB
Tone Controls	Bass (100Hz) : ± 8dB Lo-Mid (315Hz) : ± 8dB Mid (1kHz) : ± 8dB Hi-Mid (3.15kHz) : ± 8dB Treble (10kHz) : ± 8dB
Line Output	1V/1kΩ
Output Taps for Speaker Matching	2Ω, 4Ω & 8Ω
Power Supply	AC: 220-240V 50/60Hz
Protections	AC: Circuit Protector 8Amp.; ± DC: 2 x 25Amp. (T 25A L) Protected against high AC mains voltage, overload and temperature
AC Power Consumption	1500 VA
Dimensions	W482 × H186 × D530 mm
Weight	36.0kg approx.

Design and Specifications are subject to change without notice. • **AHUJA** is a registered trademark of Ahuja Radios in India and other countries.
© Copyright Ahuja Radios, 2012. All rights reserved. Any unauthorized reproduction or use of logos, images or design elements is strictly prohibited by law.
No part of the compilation may be reproduced in any manner or translated without written permission.

TRUSOUND PVT. LTD. • C-89, Sector IV, Noida, Gautam Budh Nagar-201 301 (UP)
Regd. Office : 125E, Okhla Industrial Estate, New Delhi-110 020
Tel.: +91-120-4665665 Fax : +91-120-4665621
E-mail: trusoundsupport@airtelmail.in

0K0000R1