

PMX-1632FX

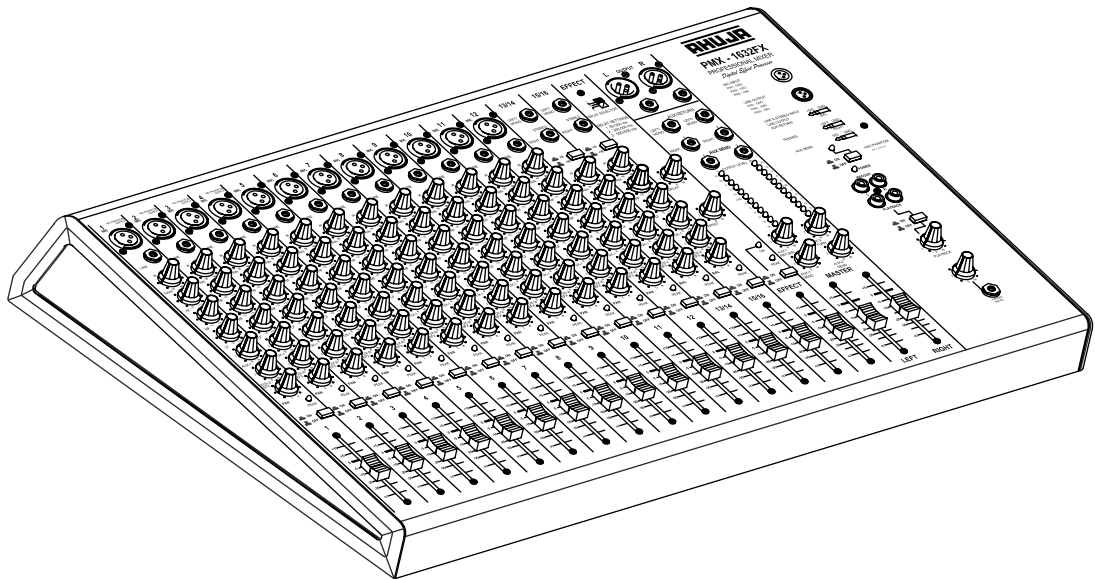

- ◆ Please read this manual thoroughly before making connections and turning on the power. Following the instructions in this manual will enable you to obtain optimum performance from your new AHUJA PA Audio Mixer.
- ◆ Please retain this manual for future reference.

• **Safety Instructions**

Read the Instructions: Please read all the instructions in this section carefully before installation or use of the product. All the safety instructions must be followed.

Retain the Instructions: Please retain this Instruction Manual for future reference.



This symbol, wherever it appears, alerts you to the presence of uninsulated hazardous voltage that may be sufficient to constitute a risk of electric shock. External wiring to any terminal marked with this symbol must be done by a trained and instructed person only.



This symbol, wherever it appears adjacent to a component, alerts you that the concerned component can only be replaced by another of the exact same specifications.

WARNING

- To reduce the risk of electric shock, do not remove the top cover. No user serviceable parts inside. Refer all servicing to qualified personnel only.

CAUTIONS

Water & Moisture: To reduce the risk of fire or electrical shock, do not expose this set to rain or moisture. Do not use this set near water or in a wet location. Do not keep any object filled with liquid, such as a vase, on top of this set. Do not insert or remove the AC mains plug with wet hands.

Power Source: The voltage & frequency of the AC mains supply, and the voltage of the external battery, (if applicable) to which this set can be connected, is marked on the rear panel of the set. Do not connect this set to any power source other than those specified on the rear panel.

Power Cord Protection: Do not cut, kink, damage or modify the AC power cord supplied with this set. Keep the AC power cord away from heaters and harmful chemicals. Do not keep any heavy object on the power cord.

Operation on Generator: When operating this set on a generator, make sure the set is switched off till the generator voltage has stabilized.

Stability: This set must be kept in a stable and flat horizontal position, and never in a tilted position. Do not place this set on an unstable stand, tripod, bracket or mount. Do not use attachments which are not supplied or explicitly recommended by the manufacturer.

Earthing: This set must be earthed properly before use. A wire from the Earth terminal on the rear panel must be connected to electrical earth.

Cleaning: Disconnect this equipment from the AC mains and external battery before cleaning. Clean with a damp cloth, but do not allow any liquid to enter the set. Do not clean with liquids or aerosols.

Contents	Page No.
• Features General Description of Product	4
• Top and Rear Panel View	5
• The Mic Line Input Section	6
• The Stereo Input Section	7
• The Output Section	8
• The Effect Section	9
• The Tape & Headphone Section	10
• Power Supply Section	10
• Operation	11
• Applications	12
• Plug wiring Details	14
• Specifications	15

• **Features/General Description of Product**

- Rugged, stable, high quality analog mixer with user-friendly construction & aesthetically designed side panels.
- Twelve MIC/LINE Balanced Mono inputs with enhanced headroom.
- Two STEREO Balanced inputs in two selectable sensitivities of -10dBu & +4dBu.
- Separate EFFECT channel is provided for controlling the built-in digital effect processor through a delay selector switch and delay, repeat and level controls.
- All MIC inputs are through 3 pin F/XLR connectors.
- All LINE & STEREO inputs are through 6.3mm stereo phone jack sockets.
- Four MIC inputs (MIC-1 to MIC-4) are available with 48V phantom supply which can be switched ON/OFF through a common switch.
- Each MIC/LINE channel has a GAIN control, 3 band active Equalizer controls, a Pre-fader AUX1 control, a Post-fader AUX2 /EFX control & a PAN control.
- Each STEREO channel has a GAIN control, 2 band active Equalizer controls, AUX1 Pre fader control, AUX2/EFX Post fader control and a BALANCE control.
- Channel ON/OFF switch provided on each individual channel.
- Peak LED for signal clipping indication.
- High precision 60mm slide fader on each channel.
- Balanced Left & Right Line outputs through M/XLR connectors as well as 6.3mm stereo phone jack sockets.
- Easy and accurate monitoring of Left & Right output levels through individual 12 segment LED array.
- Two AUX SEND outputs with level controls: one each for monitoring and effects processing applications.
- Two stereo AUX RETURN balanced inputs with level controls.
- Headphone output with Level Control for output monitoring.
- Stereo Tape Playback inputs through L&R RCA sockets provided with ON/OFF switch & level control.
- Stereo Record output through L&R RCA sockets.
- Operates on 240V 50Hz AC mains.

• Top and Rear Panel

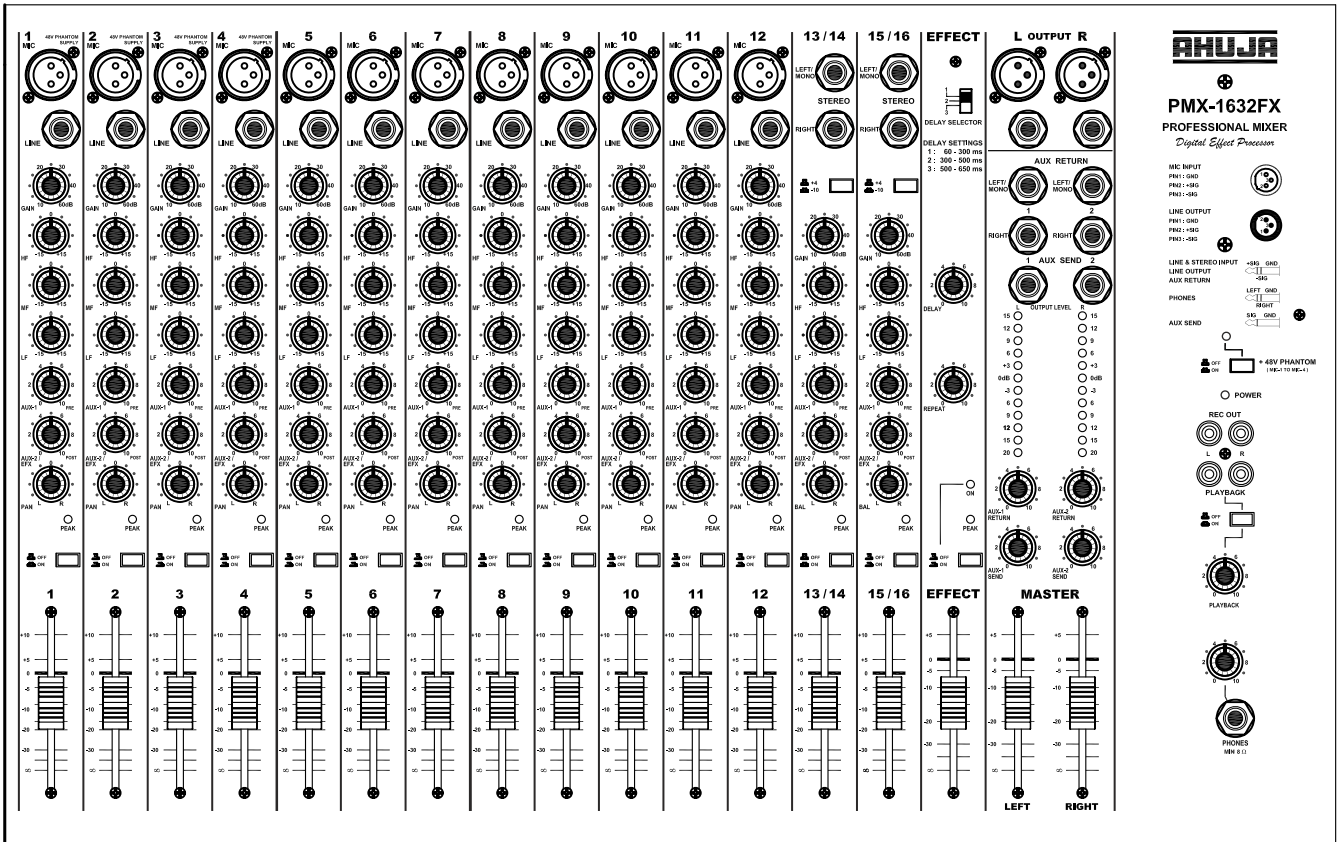

TOP PANEL



REAR PANEL

• The Mic / Line Input Section

1. (a) MIC INPUT (Channel 1 to Channel 4)

For connecting phantom powered condenser microphone through a 3 pin XLR connector in balanced mode. Keep 48V phantom switch in ON position whenever a phantom microphone is connected. If no phantom microphone is being used, then keep phantom switch to OFF so that channel 1 to channel 4 can be used for connecting low impedance dynamic or condenser (self-powered) microphone.

(b) MIC INPUT (Channel 5 to Channel 12)

For connecting low impedance dynamic & condenser (self-powered) microphone through 3 pin XLR connector, either in balanced or unbalanced mode. Refer to "Plugs Wiring Details" 1a and 1b on page 14 of this manual.

2. LINE INPUT

For connecting signal sources like CD players, Keyboards etc. through a 6.3mm stereo phone jack, either in balanced or unbalanced mode. Refer to "Plugs Wiring Details" 2a, 2b and 3 on page 14 of this manual.

3. GAIN CONTROL

The input level of both the Mic & Line signals can be adjusted by this control. It provides a gain range of more than 45dB.

4. HF CONTROL

It is used to obtain a 12dB cut or boost (shelving type) at 10kHz as center frequency.

5. MF CONTROL

It is used to obtain a 12dB cut or boost (peaking type) at 2kHz as center frequency.

6. LF CONTROL

It is used to obtain a 12dB cut or boost (shelving type) at 100Hz as center frequency.

7. AUX-1 CONTROL

This control is used to adjust the level of pre-fader signal of a channel which is then routed to AUX-1 SEND OUTPUT.

8. AUX-2 CONTROL

This control is used to adjust level of post-fader signal of a channel which is then routed to the AUX-2 SEND OUTPUT.

9. PAN CONTROL

The signal of mono input channels is distributed into LEFT & RIGHT line outputs. The PANORAMA (PAN) control is used to adjust the relative levels of the L & R outputs of this distributed signal.

10. PEAK LED

This RED LED lights up to indicate that either the input signal is overloading the input circuit or the GAIN control setting is high enough to distort the signal. Both conditions can be overcome by appropriate adjustment of GAIN control. Please ensure that this LED is NOT continuously ON.

11. ON/OFF SWITCH

This push switch is useful in switching individual channels ON or OFF during setting-up of equipment. Also, the channels which are not in use, during a program, can be switched OFF through this switch.

12. CHANNEL FADER

This slide volume control adjusts the level of pre-amplified mono signal prior to panning action.

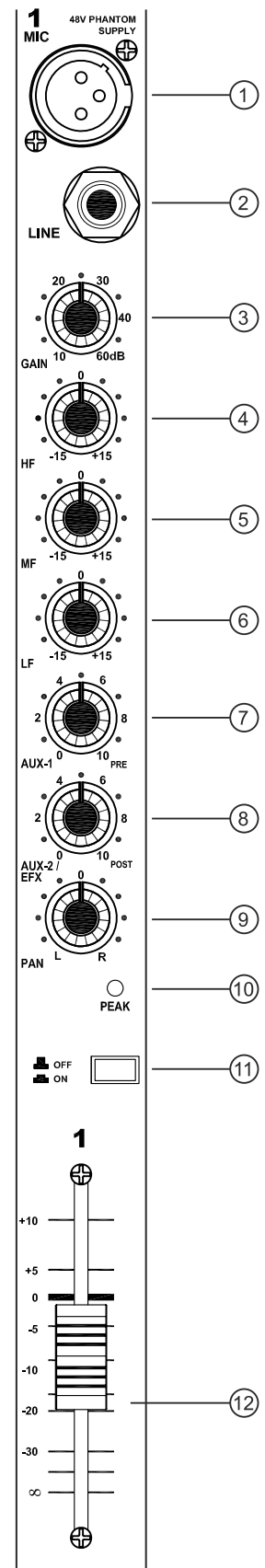

• The Stereo Input Section

1. STEREO LINE INPUT

For accepting balanced stereo line level signals through 6.3mm stereo phone jack sockets. However, these inputs can also accept either unbalanced stereo signals, balanced mono signals or unbalanced mono signals. Sources like CD Player, DVD Player, Computer line out etc. can be connected to the stereo input channel.

2. LEVEL SELECTOR SWITCH

This push switch helps in selecting the sensitivity for stereo line inputs between +4dB (high) & -10dB (low) signal levels.

3. STEREO GAIN CONTROL

The input level of both left & right signals can be adjusted by this control. It provides a gain range of more than 45dB.

4. STEREO HF CONTROL

It is used to obtain a 12dB cut or boost (shelving type) at 10kHz as center frequency.

5. STEREO LF CONTROL

It is used to obtain a 12dB cut or boost (shelving type) at 100Hz as center frequency.

6. AUX-1 CONTROL

This control is used to adjust the level of pre-fader signal which is to be routed to AUX-1 SEND OUTPUT.

7. AUX-2 CONTROL

This control is used to adjust level of post-fader signal which is to be routed to the AUX-2 SEND OUTPUT.

8. STEREO BALANCE CONTROL

The distribution level of stereo signal into the left & right line outputs is adjusted through this control.

9. PEAK LED

This RED LED lights up to indicate that either the input signal is overloading the input circuit or the GAIN control setting is high enough to distort the signal. Both conditions can be overcome by appropriate adjustment of GAIN control. Please ensure that this LED is NOT continuously ON.

10. ON/OFF SWITCH

This push switch is useful in switching individual channels ON or OFF during setting-up of equipments. Also, the channels which are not in use during a program, can be switched OFF through this switch.

11. STEREO CHANNEL FADER

This slide volume control adjusts the level of pre-amplified mono signal prior to panning action.

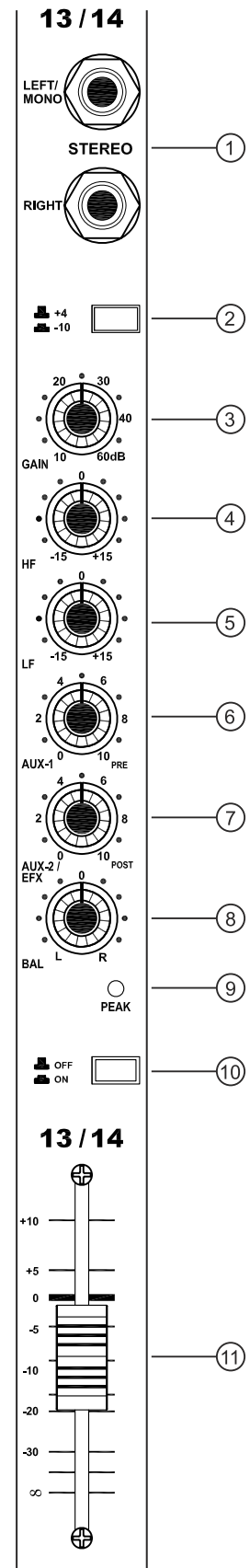

• The Output Section

1. LINE OUTPUT

Balanced Line outputs have been provided for the LEFT & RIGHT channels through individual 3 Pin M/XLR connectors as well as 6.3mm phone jack sockets. For making balanced and unbalanced output connections, refer to "Plugs Wiring Details" 1c and 1d on page 13 of this manual.

2. STEREO AUX RETURN INPUTS

There are two Stereo Aux Return Inputs: Aux Return 1 & Aux Return 2. Both inputs are designed for accepting balanced stereo signals through 6.3mm stereo phone jack sockets. However, these inputs can also accept either unbalanced stereo signals, balanced mono signals or unbalanced mono signals. The Aux return input signals are directly mixed with the L&R main mix signals so that it is available at LINE OUTPUT, REC OUTPUT & Headphone Output.

3. AUX-1 SEND OUTPUT

It provides the combined pre-fader output of all the input channels through a 6.3mm mono phone jack. The pre-fader output is mainly used for stage monitoring application.

4. AUX-2 SEND OUTPUT

It provides the combined post-fader output of all the input channels through a 6.3mm mono phone jack. The post-fader output is mainly used for external processing by effects unit, reverb unit etc.

5. LEFT & RIGHT OUTPUT LEVEL LED INDICATOR

The output signal level from Left & Right channels is indicated by an individual 12 segment LED array. Each LED array is calibrated to display output signal levels varying from -20dB to +15dB. 0dB LED glows to indicate the rated output level of +4dBu.

6. AUX-1 RETURN CONTROL

This is a two track volume control for adjusting the level of signals being fed to Stereo/Mono AUX-1 Return inputs.

7. AUX-2 RETURN CONTROL

This is a two track volume control for adjusting the level of signals being fed to Stereo/Mono AUX-2 Return inputs.

8. AUX-1 SEND CONTROL

For adjusting the output level of pre-fader signal which is taken from AUX-1 SEND Output phone jack.

9. AUX-2 SEND CONTROL

For adjusting the output level of post-fader signal which is taken from AUX-2 SEND Output phone jack.

10. LEFT MASTER CONTROL

It controls the signal level of the LEFT channel LINE output which is available through XLR / Stereo Phone Jack.

11. RIGHT MASTER CONTROL

It controls the signal level of the RIGHT channel LINE output which is available through XLR / Stereo Phone Jack.

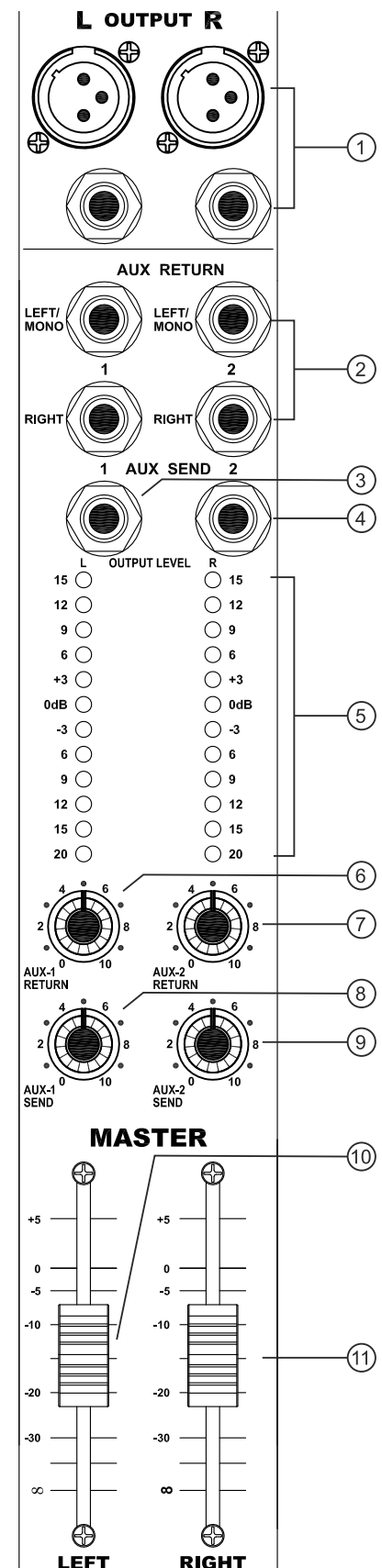

1. DELAY SELECTOR SWITCH

The built-in digital effect unit provides total delay range of 60-650ms which is divided in three groups i.e., 60-300ms, 300-500ms and 500-650ms. The desired delay setting is selectable through a delay selector slide switch.

2. DELAY CONTROL

For setting the delay time within the selected range of delay setting.

3. REPEAT CONTROL

For setting the number of repetitions within the selected delay time.

4. EFFECT ON LED

The red LED glows to indicate that the built-in effect section is switched ON.

5. PEAK LED

The red LED glows to indicate that the effect signal is distorting. The effect control should be adjusted so that this LED is NOT continuously ON.

6. EFFECT ON/OFF SWITCH

For switching the effect function ON or OFF during setting up and while in live program. Keep the switch in OFF position if digital effects are not to be used.

7. EFFECT CONTROL

For setting the level of delay signal in the overall output signal.

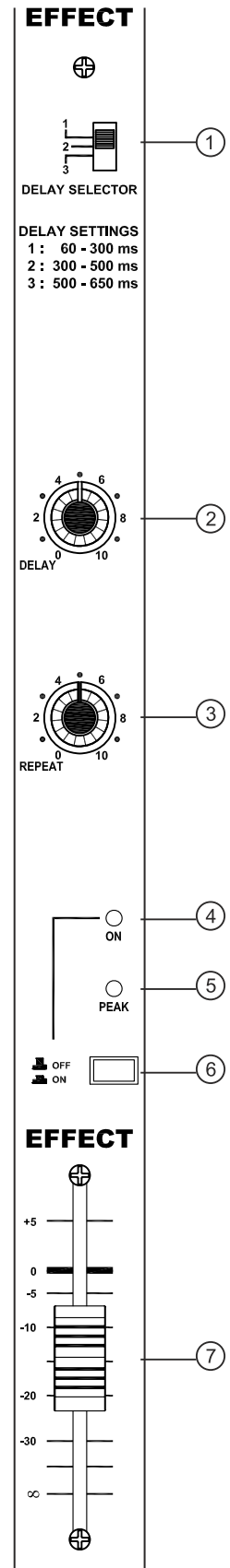

• The Tape & Headphone Section

- 48V PHANTOM LED**
The red LED glows to indicate that phantom supply to Channel 1, 2, 3 & 4 microphone inputs has been switch ON.
- 48V PHANTOM ON/OFF SWITCH**
For switching the phantom supply ON or OFF. When this switch is ON, phantom power condenser microphone can be connected on mic input channels 1 to 4.
- POWER LED**
The blue LED glows to indicate that the 240V AC mains supply has been switched ON by the mixer's power switch.
- STEREO RECORDING OUTPUT**
The stereo unbalanced recording output is available through individual left and right RCA sockets. This output can be used to record the main stereo mix signal from the mixer onto a tape recorder, CD recorder etc. Also, an additional power amplifier can be connected to these RCA output sockets. The recording output level is affected by the setting of master fader controls.
- STEREO PLAYBACK INPUT**
The left & right RCA socket are provided for connecting the stereo unbalanced line level signal from a stereo cassette player, a CD player, a DVD player, a USB player, an IPOD etc. The stereo playback input is an independent input channel, which is directly mixed with the L&R main mix signal. This means that stereo playback signals are available at LINE OUTPUT, REC OUTPUT & Headphone output.
- PLAYBACK ON/OFF SWITCH**
For switching the playback signal ON or OFF during setting-up & live program.
- PLAYBACK CONTROL**
It is used to adjust the level of playback signal into the main mix signal.
- HEADPHONE CONTROL**
It is used for controlling the level of stereo signal which is available as headphone output.
- HEADPHONE OUTPUT**
For connecting a stereo headphone (not less than 8Ω impedance) through a 6.3mm stereo phone jack. The headphone output is used for personal monitoring & its level is not effected by the setting of master control.

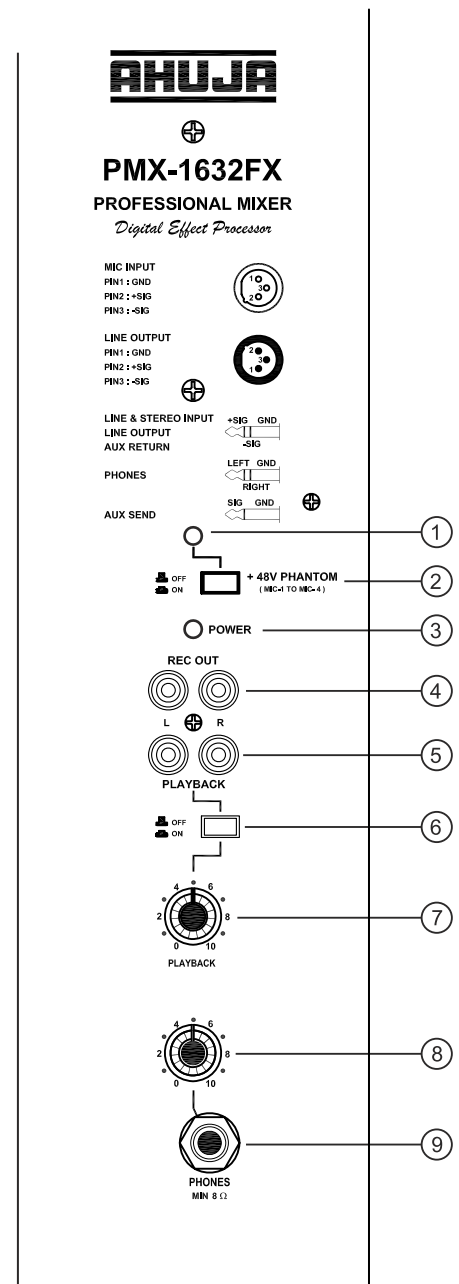

• The Power Supply Section

- POWER SWITCH**
Push the top part of the knob to switch the mixer ON. Push the bottom part of the knob to switch the mixer OFF.
- AC MAINS FUSE Rating 1Amp 250V (T 1A L)**
This protects the mixer from any excessive current flow.
- 2 CORE AC MAINS CABLE WITH PLUG**
- EARTH TERMINAL**

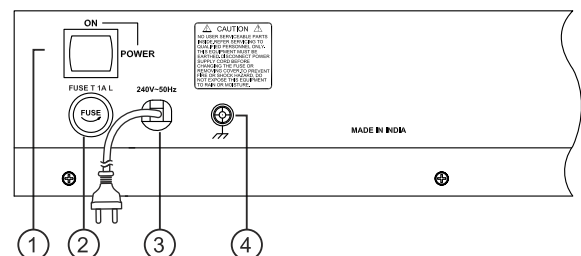

1. Please ensure that AC mains supply to all the equipments is switched OFF.
2. Connect the desired number of input sources like phantom powered microphones, wired microphones, CD player, DVD player, keyboard etc., to the appropriate input sockets of the mixer.
3. Connect the power amplifiers, external processors, recording machine, headphone etc., to the appropriate output sockets of the mixer.
4. All the rotary & slide volume controls of the mixer as well as that of the peripheral equipments should be set to minimum position.
5. All the tone controls (HF, MF & LF), PAN controls & BAL controls should be set at center (FLAT) position.
6. Keep all the push switches of the mixer in OFF position.
7. Connect all the equipments to their respective AC mains supply sockets.
8. Always switch ON the mixer first and all the power amplifiers in the last. In between, other equipments can be switched ON.
9. Now, GAIN control setting should be carried out for channels which have microphone as an input source. The microphone XLR input is designed to accept dynamic and condenser (self powered) microphones in both balanced as well as unbalanced mode of connection. The microphone XLR input channels 1 to 4 can be used for connecting condenser (phantom powered) microphones in balanced mode of connection.
10. Press the microphone channel switch to ON.
11. Switch the microphone ON and speak a few words through it while turning up the GAIN control to a position where the PEAK LED just starts to flicker.
12. Now speak loudly into the microphone and then readjust the GAIN control to a position where the PEAK LED just flickers.
13. For desired tonal balance, adjust HF, MF & LF controls and then carry out the final setting of GAIN control as explained in point #12. The setting of tone controls can be different for each microphone input channel.
14. Similarly, the setting of GAIN control for LINE input channels should be done with reference to the setting of tone controls & flickering of the PEAK LED.
15. The setting of GAIN control for STEREO input channels should also be done in a similar way as explained in point #14.
16. After completing the GAIN setting of all the channels, adjust the slide control of each channel to obtain the desired mix at the output.
17. For using the built-in digital effect processor, put ON the Effect switch and select the desired range of delay settings. Obtain the desired echo or reverb effect from delay control & number of repetitions from repeat control. The level of this processed signal should be adjusted through AUX-2/EFX control in each channel and then through Effect control in the EFFECT channel.
18. The overall level of LEFT & RIGHT LINE output signals should be adjusted through respective MASTER slide controls.
19. Use PAN control to adjust the level of mono input signal which is contributed to LEFT & RIGHT channels.
20. Use BAL control to adjust the level of stereo (or L/mono) input signal which is contributed to LEFT & RIGHT channels.
21. The level of pre-fader output of each input channel, that is contributed to the main AUX-1 Send output, should be adjusted through AUX-1 control of that channel.
22. Similarly, the post-fader output of each input channel, that is contributed to the main AUX-2 Send output, should be adjusted through AUX-2 control of that channel.
23. The post-fader signals, after external processing, are fed back to the mixer through AUX RETURN inputs and mixed with the main L & R outputs through AUX-1 RETURN volume controls.
24. Always use interconnecting cables with appropriate connectors which are suitably wired for proper functioning of the mixer & its peripheral equipments.

• Applications

LIVE PERFORMANCE

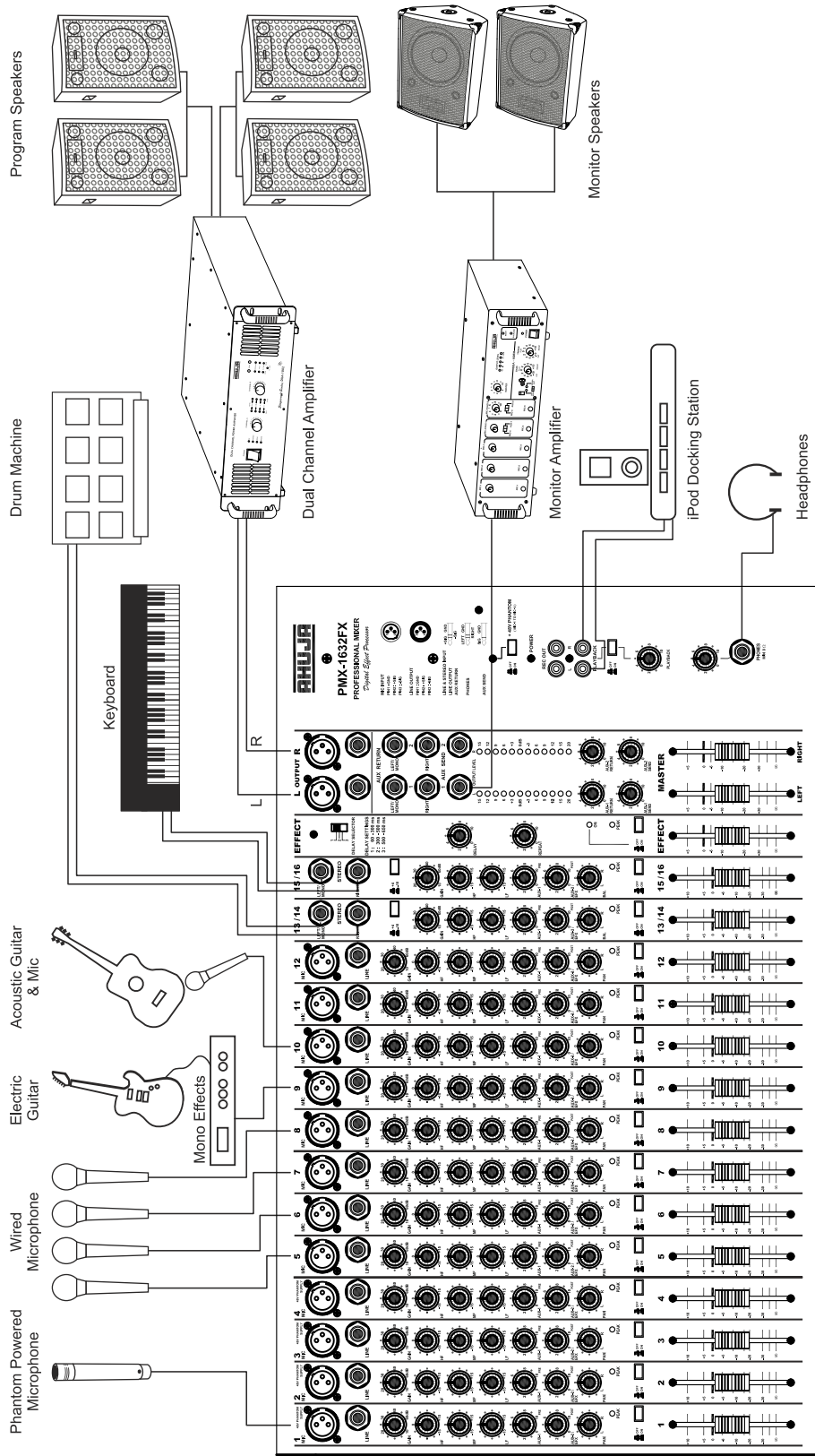

OPEN CONFERENCE / CONVENTION SETUP

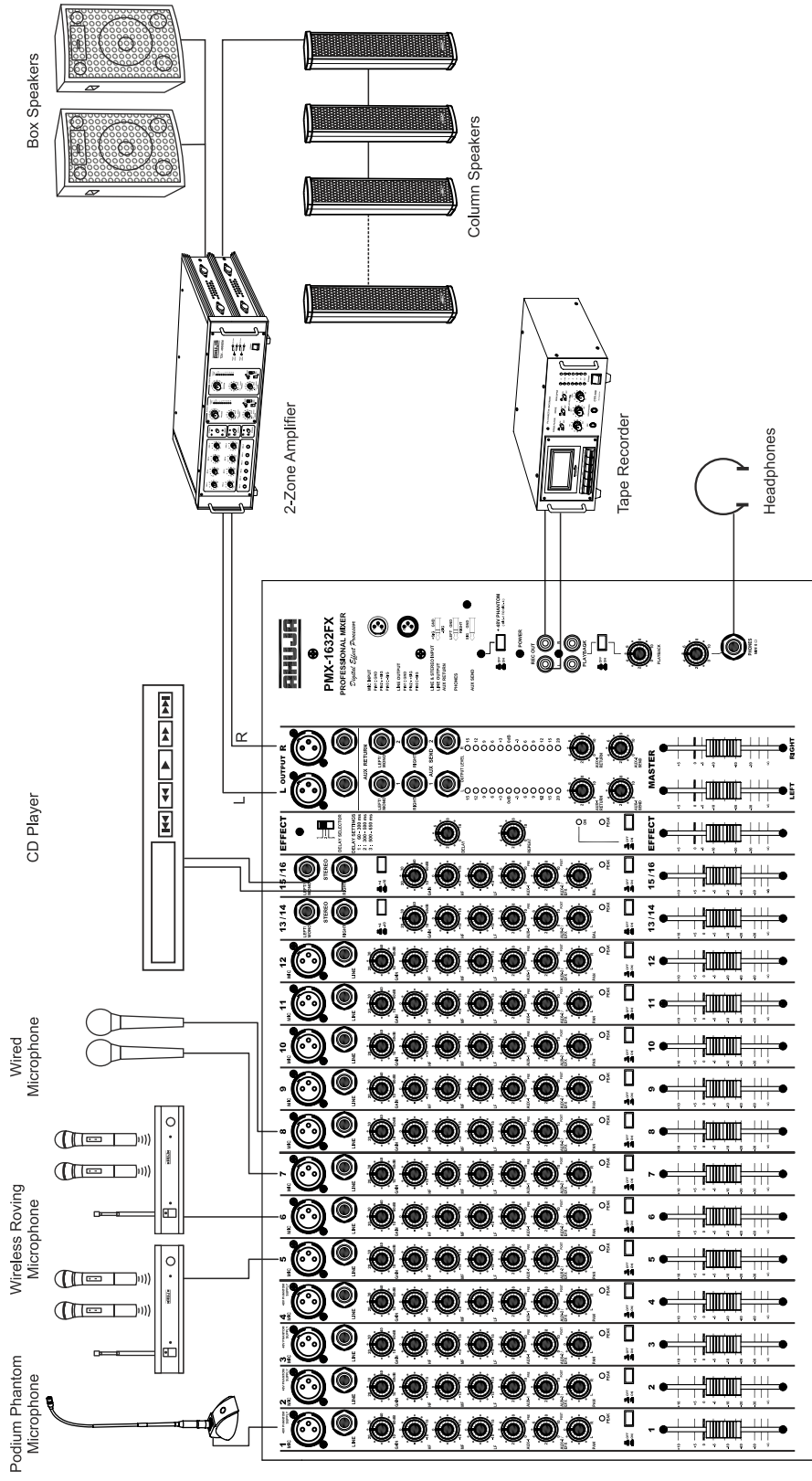

• Plugs Wiring Details

1. Pin connections of a 3 pin XLR plug:

a) MIC Input (Balanced)

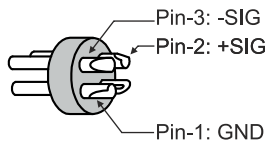

b) MIC Input (Unbalanced)

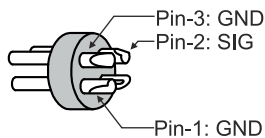

c) LINE Output (Balanced)

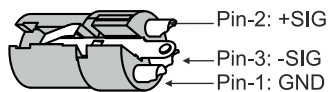

d) LINE Output (L & R) (Unbalanced)

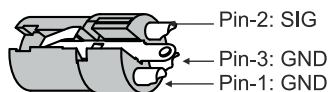

2. Pin connections of a 6.3mm (1/4") Stereo Phone Plug for LINE Input, STEREO Input, AUX RETURN Input & LINE Output.

a) For balanced signal

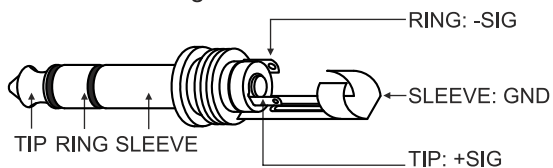

b) For unbalanced signal

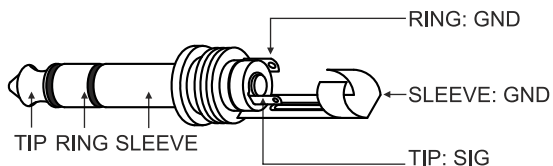

3. Pin connection of a 6.3mm (1/4") Mono Phone Plug for connecting unbalanced signal in LINE Input, STEREO Input, AUX RETURN Input, LINE Output and AUX SEND Output.

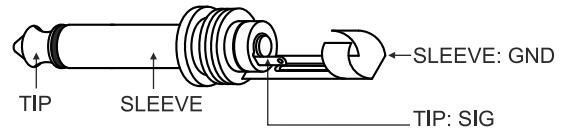

4. Pin connections of a 6.3mm (1/4") Stereo Phone Plug for Headphone Output.

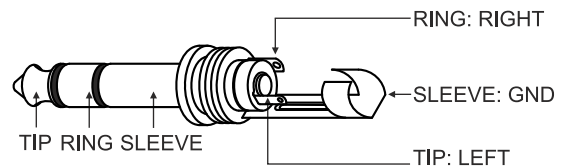

5. Pin connection of an RCA plug for RECORD Output and PLAYBACK Input.

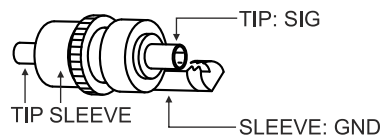

• Specifications

MIC INPUT	
Impedance/Gain	: 2k Ω Balanced/65dB
LINE INPUT	
Impedance/Gain	: 20k Ω Balanced/45dB
STEREO INPUT (L/Mono & R)	
Impedance/Gain (-10dB Input)	: 10k Ω Balanced/14dB
Impedance/Gain (+4dB Input)	: 10k Ω Balanced/0dB
THD	: <0.08%
FREQUENCY RESPONSE	
L/R Line Output	: 25Hz - 20kHz (+0, -1dB)
EQUALIZATION	
Bass/Mid/Treble	: \pm 12dB at 100Hz/2kHz/10kHz
CLIP LED INDICATION	: 4 dB prior to true clip
LINE OUTPUT	
Nominal/Max Level	: 4dBu/21dBu (1.22V/9V)
IMPEDANCE	: 600 Ω
DELAY SYSTEM	: Digital Signal Processing
DELAY RANGE SETTINGS	: 1: 60-300ms, 2: 300-500ms, 3: 500-650ms
HEADPHONE OUTPUT	: 200mV at 8 Ω , THD <1%
MAXIMUM GAIN	
Mic Input to Line Outputs	: 78dB
Line Input to Line Outputs	: 58dB
Stereo Input to Line Outputs	: 28dB (-10dBu Input) 14dB (+4dBu Input)
AUX Send (Pre)	: 1.4V/100 Ω Unbalanced
AUX Send (Post)	: 2.7V/100 Ω Unbalanced
AUX Return (L&R)	: 150mV/10k Ω Balanced
TAPE	
Record Output	: 250mV/600 Ω
Playback Input	: 250mV/1k Ω (variable thru' GAIN control)
SIGNAL TO NOISE RATIO	: >70dB
POWER SUPPLY	: AC: 220-240V, 50Hz
DIMENSIONS	: W609 \times H110 \times D435mm
WEIGHT	: 9.7kg

Design and Specifications are subject to change without notice owing to continuous product up-gradation. Technical specifications are subject to production tolerances.
We cannot be held responsible for printing errors, should they occur. **AHUJA** is a registered trademark of Ahuja Radios in India and other countries.
© Copyright Ahuja Radios, 2013. All rights reserved. Any unauthorized reproduction or use of logos, images or design elements is strictly prohibited by law.
No part of this compilation may be reproduced in any manner or translated without written permission.

TRUSOUND PVT. LTD. ● C-89, Sector IV, Noida, Gautam Budh Nagar-201 301 (UP)
Regd. Office : 125E, Okhla Industrial Estate, New Delhi-110 020
Tel.: +91-120-4665665 Fax : +91-120-4665621
E-mail: trusoundsupport@airtelmail.in

E. & O. E. 0K01/10