

AHUJA®

PA Amplifier 800W RMS / 1050W Max.

OPERATION MANUAL

UBA-800DP

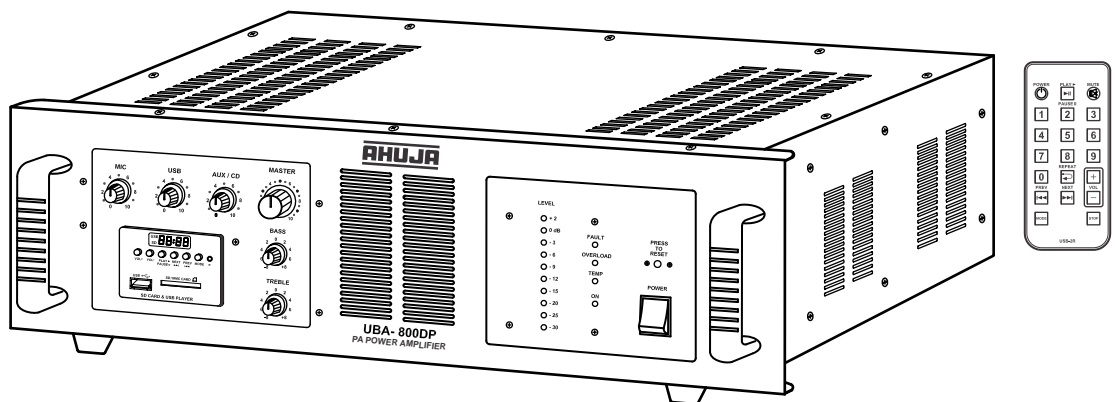

- ◆ Thank you for purchasing the AHUJA PA Amplifier.
- ◆ Please read this manual thoroughly before making connections and turning on the power. Following the instructions in this manual will enable you to obtain optimum performance from your new AHUJA PA Amplifier.
- ◆ Please retain this manual for future reference.

• Safety Instructions

Read the Instructions: Please read all the instructions in this section carefully before installation or use of the product. All the safety instructions must be followed.

Retain the Instructions: Please retain this Instruction Manual for future reference.



This symbol, wherever it appears, alerts you to the presence of uninsulated hazardous voltage that may be sufficient to constitute a risk of electric shock. External wiring to any terminal marked with this symbol must be done by a trained and instructed person only.



This symbol, wherever it appears adjacent to a component, alerts you that the concerned component can only be replaced by another of the exact same specifications.

WARNING

- To reduce the risk of electric shock, do not remove the top cover. No user serviceable parts inside. Refer all servicing to qualified personnel only.
- Before replacing any fuse, make sure the set is switched off and disconnected from the AC mains or any other power source. Replace a fuse only with another of exactly same specification.

CAUTIONS

Water & Moisture: To reduce the risk of fire or electrical shock, do not expose this set to rain or moisture. Do not use this set near water or in a wet location. Do not keep any object filled with liquid, such as a vase, on top of this set. Do not insert or remove the AC mains plug with wet hands.

Power Source: The voltage & frequency of the AC mains supply, to which this set can be connected, is marked on the rear panel of the set. Do not connect this set to any power source other than those specified on the rear panel.

Power Cord Protection: Do not cut, kink, damage or modify the AC power cord supplied with this set. Keep the AC power cord away from heaters and harmful chemicals. Do not keep any heavy object on the power cord.

Operation on Generator: When operating this set on a generator, make sure the set is switched off till the generator voltage has stabilized.

Ventilation: This set should be situated so that its location or position does not interfere with its proper ventilation. Do not cover the ventilation holes/ slots. Do not insert or drop anything into the ventilation holes/ slots.

Stability: This set must be kept in a stable and flat horizontal position, and never in a tilted position. Do not place this set on an unstable stand, tripod, bracket or mount. Do not use attachments which are not supplied or explicitly recommended by the manufacturer.

Cover Strip: The cover strip of the output terminal strip, must be replaced after making connections. Failure to do so may result in exposure to hazardous voltages.

Earthing: This set must be earthed properly before use. A wire from the Earth terminal on the rear panel must be connected to electrical earth.

Cleaning: Disconnect this equipment from the AC mains and external battery before cleaning. Clean with a damp cloth, but do not allow any liquid to enter the set. Do not clean with liquids or aerosols.

Exposure to Heat: Do not touch the heatsinks while the set is working.

Contents	Page No.
• Features/General Description of Product	4
• Front Panel Controls & Features	5
• Rear Panel Controls & Features	6
• MP3 Playback Facility Controls & Features	7
• Pairing of Bluetooth Device	8
• Interconnections	9
• Speaker Connection Guidelines	10
• Typical Applications	11
• Specifications	12

• Features/General Description of Product

- Designed for use in a wide variety of PA applications and DJ performances.
- UBA-800DP is a 800 Watts amplifier which can be connected to various input sources like a Microphone, PA Mixer, CD player, DJ Mixer, Cassette player, Keyboard etc.
- Built-in MP3 player with remote control and can play USB drive as well as SD/MMC card.
- The amplifier comprises of but and boost type Bass and Treble controls which provides precise and accurate tonal setting of the programme material.
- Line Input and Line Output have been provided to enable interconnections with other power amplifiers.
- Circuit Protector Device has been provided which safeguards the amplifier against overload and short circuit.
- The amplifier is fully protected for variations in AC supply due to Genset / Mains fluctuation upto 300V.
- Indicator LEDs for Power, Signal, Temp, Overload and Fault conditions have been provided.
- Ease of operation, combined with service accessibility has been optimized in the design.

• Front Panel Controls & Features

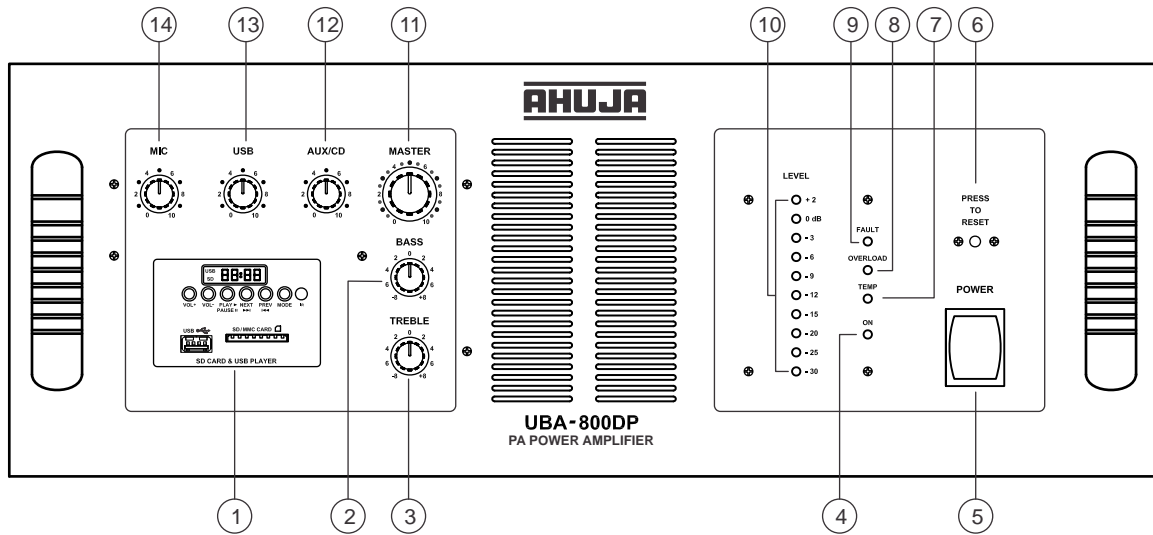

1. MP3 Playback Facility

See Page No. 7 & 8.

2. BASS Control

For attenuating or boosting the low frequency signal level with a centre frequency of 100Hz.

3. TREBLE Control

For attenuating or boosting the high frequency signal level with a centre frequency of 10kHz.

4. POWER LED

The glowing of this red LED indicates that the amplifier is switched ON.

5. POWER Switch

Push the top part of the knob to switch the amplifier ON. Push the bottom part of the knob to switch the amplifier OFF.

6. RESET Button

This button pops out when the circuit protector trips. Rectify the cause and press the RESET button for resetting to normal operation of the amplifier.

7. TEMPERATURE LED

The glowing of this yellow LED indicates excessive temperature of the output devices. The protection circuit then mutes the input signals. The amplifier will remain at mute status, till the amplifier cools down to normal temperature.

8. OVERLOAD LED

The glowing of this red LED indicates that the circuit protector has tripped. The AC mains supply to the amplifier is cut-off till the fault is rectified and the reset button is pressed.

9. FAULT LED

The glowing of this red LED indicates that some fault has occurred in the amplifier. The protection circuit then mutes the input signals. The amplifier will remain at mute status till the fault is rectified.

10. LED Array

This indicates the output level of the amplifier. Acceptable output levels are indicated by occasional flickering of the 0dB LED. If this LED glows continuously then it is advisable to reduce the input signal level either from the signal source or the amplifier volume controls.

11. MASTER Volume Control

For adjustment of the overall volume level of the amplifier.

12. AUX / CD Volume Control

13. USB Volume Control

14. MIC Volume Control

Rear Panel Controls & Features

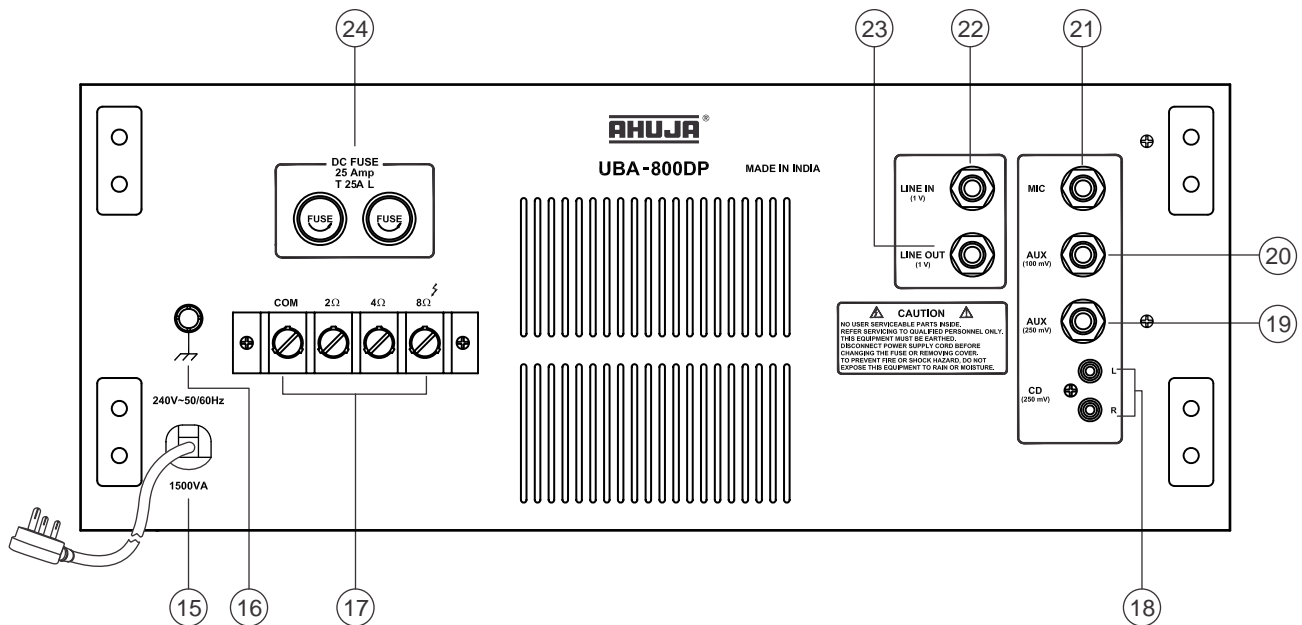

15. 3 Core AC Mains Cable with Plug

16. Earth Terminal

17. SPEAKER Terminal Block (2Ω, 4Ω & 8Ω)

For connecting low impedance speakers.

18. CD Input RCA Sockets

For connecting stereo inputs such as a CD player, DJ Mixer etc.

CD Input should be used only when the Aux Input is not connected.

19. AUX Input Jack Socket (250mV)

For accepting an unbalanced signal from an auxiliary source of higher output mixer, CD Player etc.

20. AUX Input Jack Socket (100mV)

For accepting an unbalanced signal from an

auxiliary source like a Tuner, Cassette Player, Echo Mixer or Audio Mixing Console etc.

Aux Input should be used only when the CD Input is not connected.

21. MIC Input Jack Socket

For accepting unbalanced signal from a low impedance microphone.

22. LINE Input Jack Socket

For connecting an external Mixer to enhance the number of inputs.

23. LINE Output Jack Socket

For connecting to a booster amplifier to obtain combined higher power output.

24. DC Fuses Rating 25 Amp 250V (T 25A L)

These protect the amplifier from any excessive current flow.

Caution

- The equipment must be earthed properly before operating it to avoid electric shock. A wire from the Earth Terminal must be connected to electrical earth for safe operation.

• MP3 Playback Facility: Controls & Features

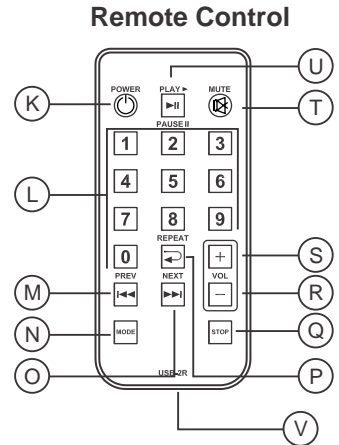
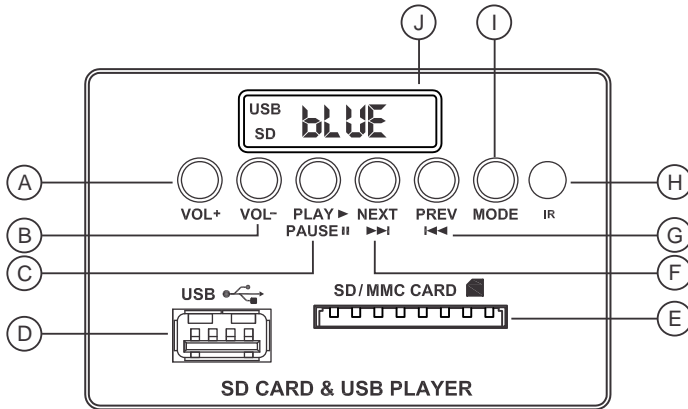

- A. **VOL+** : To increase volume level of MP3 player.
- B. **VOL-** : To decrease volume level of MP3 player.
- C. **▶|| PLAY/PAUSE**: Press PLAY/PAUSE once to Pause if music is already playing. Press PLAY/PAUSE again to resume playing.
- D. **USB Connector**: Insert the USB drive here. While inserting USB drive into the USB connector, hold the USB drive in such a way that hollow part of the USB drive is downwards as shown in figure.

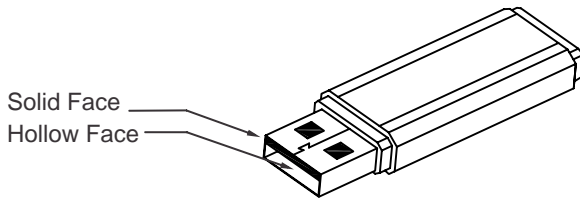

Any forceful insertion in wrong direction will damage the connector.

- E. **SD/MMC Card Connector**: Insert the SD/MMC Card into the slot to play. When taking out the card, pull the card to take out.

While inserting SD/MMC card into the slot, ensure that the card is inserted in such a way that all pins are facing upward and cut is towards left as shown in figure.

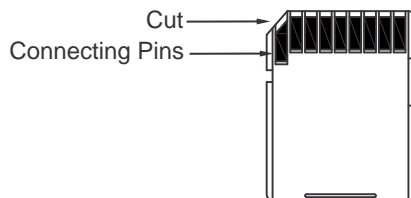

- F. **▶▶ Next**: Press NEXT to select next forward music track. Pressing NEXT repeatedly will move the system to successively next forward tracks.
- G. **◀◀ Prev**: Press PREV to Select the previous track. Pressing PREV repeatedly will move the system to successively previous tracks.

- H. **IR Sensor**: Picks up signal from the Remote control. Point the Remote control toward this sensor for best results.
- I. **Mode**: To select USB, SD or Bluetooth mode. The default condition of the amplifier is Bluetooth mode.
- J. **LED Display**: Instantly displays 3 digits of the track selected play to i.e 001 to 999. During play, display the time duration of the track played.

Remote Control

- K. **Power**: Press once to switch off MP3 digital player, press again to switch ON.
- L. Number key 0 to 9. To choose the track number to be played.
- M. **◀◀**: To select the previous track.
- N. **MODE** : To select SD or USB if both are inserted.
- O. **▶▶**: Press to select the next track.
- P. **↺** Press once to repeat the song being played. Press again to repeat all the songs.
- Q. **STOP**: Press to stop the track being played.
- R. **Vol-**: Press to decrease the volume of Digital Player.
- S. **Vol+**: Press to increase the volume of Digital Player.
- T. **MUTE**: Press once to mute the sound, press again to resume the sound.
- U. **▶|| PLAY/PAUSE**: Press Play/Pause once to Pause when music is already playing. Press Play/Pause again to resume playing.
- V. **Battery Replacement**: Pull out the battery tray and replace the battery with positive electrode facing upwards as shown in fig. below. Push the battery compartment back to the close position. Use CR2025 or equivalent lithium coin cell.

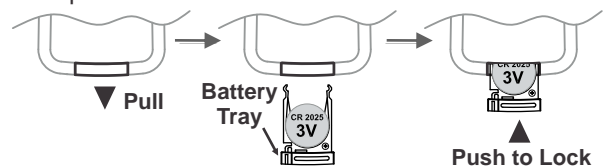

• Pairing of Bluetooth Device

SWITCH ON the amplifier in use. The Default condition of the MP3 digital Player is BLUETOOTH mode. The display shows "bLUE.

To play the MP3 programme from mobile phone or laptop, the PAIRING of the Bluetooth devices of mobile phone & Amplifier is necessary.

Pairing is done as follow :-

SELECT the Bluetooth option in Mobile Phone or laptop & follow the instruction as appear on mobile/laptop.

Normally following general instructions are followed:

Press ACTIVATE /ON/DISCOVERABLE/SEARCH, etc, as applicable in the mobile phone or laptop used.

The mobile phone or laptop starts searching for the new Bluetooth device. The moment either TDM011 or BTSPEAKER appears on the mobile phone or laptop, select the new device i.e. TDM011 or BTSPEAKER and press OK or allow it to appear on mobile. System is ready to use.

In some mobiles, it asks for a code to allow access. The press 0000 and follow the steps, like pressing "OK", "Allow once", "Allow always" etc. and make the device ready for use.

Select the MP3 programme from mobile phone or laptop and press PLAY. The same song starts playing on the Ahuja Amplifier. We can SELECT Volume, FF, Rewind, Play/Pause function either from keys on the Amplifier or through Remote Control.

Note: It is not necessary that all functions of remote control will be activated through Bluetooth and compatibility varies from mobile to mobile.

• Interconnections

- The amplifier can be placed as a tabletop unit. The amplifier uses an efficient forced cooling arrangement, therefore, the amplifier should be situated so that the front and rear ventilation slits are not obstructed.
- Do not keep the amplifier very close to a wall so that air flow through the opening in the back plate is obstructed.
- The amplifier must be powered through an AC earthed mains outlet.
- All connections must only be carried out or changed with the amplifier switched OFF.
- To avoid loud switching noise, always switch ON the power amplifier after all other units of the audio system have been switched ON. After operation, switch it OFF first and then the other units.
- The connection diagrams that follow, display the typical types of input sources (Mic, Keyboard, Cassette Player, DJ Mixer, CD Player, USB player etc.) and box speakers which can be connected to the amplifier. For correct connections and operation check the specifications of the connected equipment.

(Refer to page 9 for illustration)

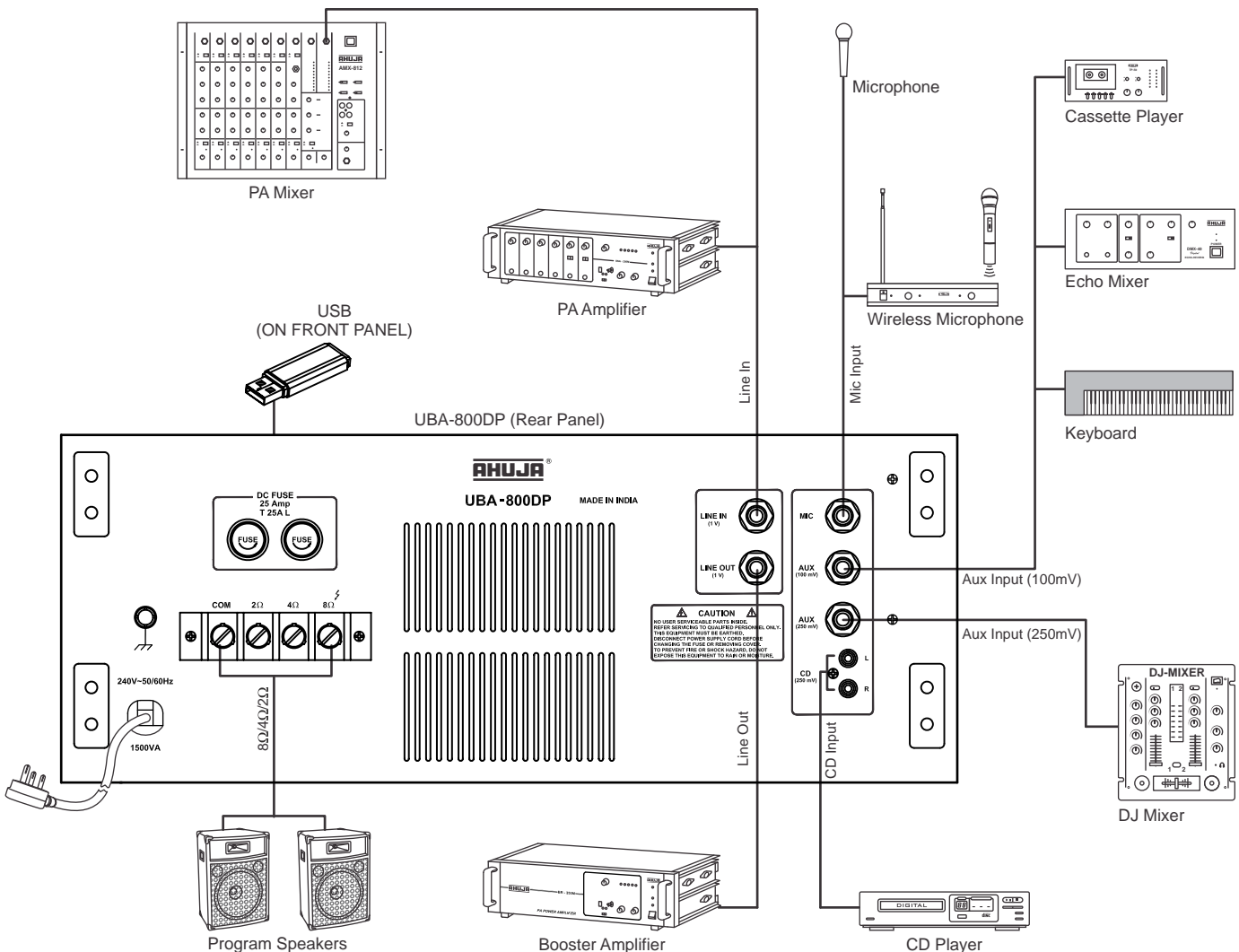

• Speaker Connection Guidelines

UBA-800DP is a high-powered amplifier. Therefore it is very important that correct loudspeaker connections are made to avoid damage to the amplifier or speakers.

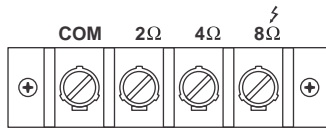

Low Impedance Speaker Connections

- Box type Speakers can be directly connected to Com-2Ω / 4Ω / 8Ω Terminal Strip.

Connecting Four SAX-300DX Speakers

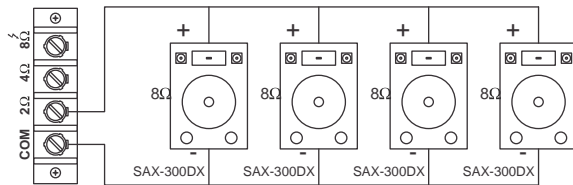

$$\text{Resultant Impedance} = (8\Omega / 4) = 2\Omega$$

The four SAX-300DX Speakers (each speaker has 8Ω impedance) should be wired in parallel as shown in figure. The resulting impedance of the speaker system will be 2Ω. The speaker system should be connected to the 2Ω tap of the amplifier.

Connecting Three SRX-500 Speakers

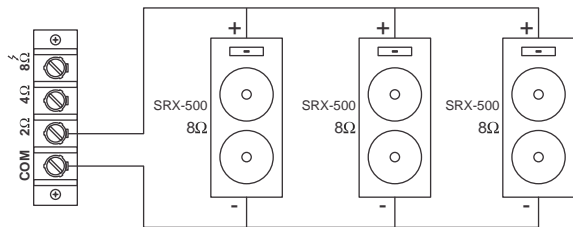

$$\text{Resultant Impedance} = (8\Omega / 3) = 2.66\Omega$$

The three SRX-500 speakers (each speaker has 8Ω impedance) should be wired in parallel as shown in figure. The resulting impedance of the speaker system is 2.66Ω. Thus they should be connected to the 2Ω tap of the amplifier.

Connecting Four SPX-400 Speakers

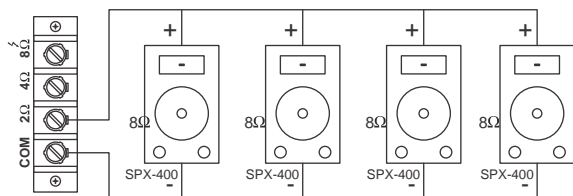

$$\text{Resultant Impedance} = (8\Omega / 4) = 2\Omega$$

The four SPX-400 speakers (each speaker has 8Ω impedance) should be wired in parallel as shown in figure. The resulting impedance of the speaker system is 2Ω. Thus they should be connected to the 2Ω tap of the amplifier.

Connecting One SWX-650 Subwoofer



One SWX-650 subwoofer system has an impedance of 8Ω. Thus it should be connected to the 4Ω tap of the amplifier as shown in the figure.

IMPORTANT

- Speakers should be connected only to either COM-2Ω or COM-4Ω or COM-8Ω terminals as illustrated above but never to more than one set of terminals.

Connecting Two UBA-800DP To Make A 1600W Mono System

1. Insert USB or connect the output of the CD Player to the CD Input of the first UBA-800DP using a patch cord with RCA plugs at both ends.
2. Connect the Line Out of the first UBA-800DP to the Line In of the second UBA-800DP using a patch cord with ¼" phone plugs at both ends.
3. Loudspeaker connections to both the amplifiers should be done independently. Each amplifier is connected to a speaker stack which comprises of four SAX-300DXs.
4. The four speakers in each stack will be wired together in parallel (resulting impedance is 2Ω) and connected to the COM and 2Ω tap of their respective UBA-800DPs.
5. Finally, when operating the system, any adjustment in the overall tonal quality of the sound can be made through the Bass & Treble of the first UBA-800DP only.
6. This MONO system is capable of delivering output power of 1600W at 10%THD which is suitable for various indoor as well as outdoor applications.

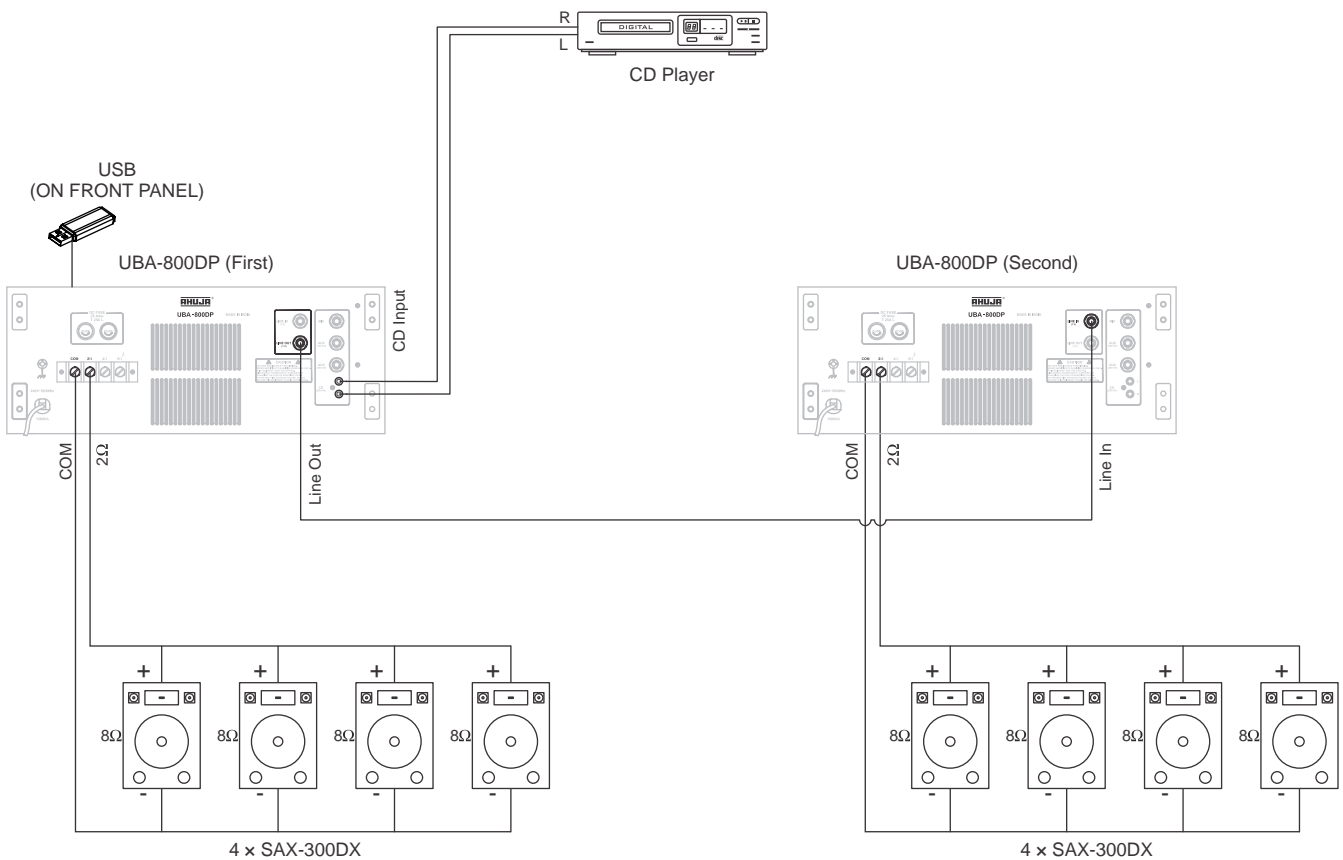

• Specifications

MODEL	UBA-800DP
Power Output	1050W RMS Max. 800W RMS at 10%THD 750W RMS at 5% THD 700W RMS at 2% THD
Output Regulation	≤ 2dB no load to full load at 1kHz
Input Channels	1 × Mic 1mV / 4.7kΩ (Mic source impedance 50Ω to 1kΩ) 1 × Aux 100mV / 470kΩ 1 × Aux 250mV/20kΩ 1 × CD 250mV / 20kΩ Line Input 1V / 10kΩ
MP3 Playback	Built-in MP3 playback facility (USB, SD and MMC card) Remote Control provided
Frequency Response	50Hz–18,000Hz ±3dB
Signal to Noise Ratio	60dB
Tone Controls	Bass (100Hz) : ± 8dB Treble (10kHz) : ± 8dB
Line Output	1V/1kΩ
Output Taps for Speaker Matching	2Ω, 4Ω & 8Ω
Power Supply	AC: 220-240V 50/60Hz
Protections	AC: Circuit Protector 8Amp.; ± DC: 2 x 25Amp. (T 25A L) Protected against high AC mains voltage, overload and temperature
AC Power Consumption	1500 VA
Dimensions	W482 × H186 × D530 mm
Weight	37.2kg approx.

Design and Specifications are subject to change without notice owing to continuous product up-gradation. Technical specifications are subject to production tolerances.

We cannot be held responsible for printing errors, should they occur. **ahuja** is a registered trademark of Ahuja Radios in India and other countries.

© Copyright Ahuja Radios, 2013. All rights reserved. Any unauthorized reproduction or use of logos, images or design elements is strictly prohibited by law.

No part of this compilation may be reproduced in any manner or translated without written permission.

TRUSOUND PVT. LTD. • C-89, Sector IV, Noida, Gautam Budh Nagar-201 301 (UP)

Regd. Office : 125E, Okhla Industrial Estate, New Delhi-110 020

Tel.: +91-120-4665665 Fax : +91-120-4665621

E-mail: trusoundsupport@airtelmail.in

E. & O. E. 0K/12/13